

CLARK COUNTY REGIONAL OZONE & PRECURSOR STUDY “DRAFT” FINAL REPORT (P.O. 225900)

Prepared for:

**Mr. William Cates
Clark County**



**Department of Air Quality & Environmental Management
500 South Grand Central Parkway
Las Vegas, NV 89106**

Prepared by:

**David Bush
Robert Baxter
William Knuth
Don Lehrman
Paul Fransioli
David Yoho**



**Dr. Wendy Goliff
Desert Research Institute
Reno, NV**

**Dr. Dennis Fitz
CE-CERT
University of California, Riverside
Riverside, CA**

March 9, 2006

CLARK COUNTY REGIONAL OZONE & PRECURSOR STUDY
“DRAFT” FINAL REPORT (P.O. 225900)

Prepared for:

Mr. William Cates
Clark County



Department of Air Quality & Environmental Management
500 South Grand Central Parkway
Las Vegas, NV 89106

Prepared by:

David Bush
Robert Baxter
William Knuth
Don Lehrman
Paul Fransioli
David Yoho



Dr. Wendy Goliff
Desert Research Institute
2215 Parkway
Reno, NV 89512

Dr. Dennis Fitz
CE-CERT
University of California, Riverside
1084 Columbia Ave.
Riverside, CA 92507

March 9, 2006

ACKNOWLEDGEMENTS

This work was performed for the Clark County Department of Air Quality & Environmental Management under Purchase Order No. 225900. Messrs. William Gates and John Koswan provided overall project management. A large field program such as CCROPS is successful only when all the participants share the hard work necessary and coordinate their activities. Therefore, we would like to express our gratitude to the DAQEM staff members who participated in planning and operational meetings, and those who contributed to the field monitoring effort. In particular, Mr. Phil Wiker, who participated in daily forecasts; and Messrs. Mick Turner and Al Lesksys who were instrumental in obtaining project-specific monitoring sites.

Dr. Krys Stave of the University of Nevada, Las Vegas is commended for coordinating the aircraft measurements and piloting the glider while tending to the monitors. Drs. David DuBois and Mark Green of DRI, Dr. Daryl Randerson and Ray Dennis of NOAA/SORD must be acknowledged for coordinating their remote wind sensing measurements and balloon-borne measurements, respectively, with the CCROPS field measurements.

Recognition is due to Ms. Elizabeth Niccum of T&B Systems who assembled all the project-specific measurements and integrated them into a consistent relational database. Many thanks to Ms. Susan Hynek who was central in compiling all the text, figures, and tables from the various authors into a consistent document.

EXECUTIVE SUMMARY

During the last two and a half decades, the Las Vegas Valley has emerged as one of the fastest growing metropolitan areas in the nation, leading to increased emissions into the atmosphere that are precursors to ozone production. In recent years, concentrations of ozone in Clark County have approached, and on occasion exceeded, the new 8-hr ambient air quality standard as defined by the recently adopted Federal Ozone Standard. These exceedances increase the potential for a violation of the federally mandated Clean Air Act, and the necessity for developing control strategies. Planning realistic, cost-effective control strategy requires a comprehensive understanding of the origin and fate of ozone and ozone precursors. Characterizing ozone in Clark County and the Las Vegas Valley is a challenging process. Local airflow is a complex diurnal cycle resulting from mountain and valley dynamic influences when the area is under high-pressure weather systems that suppress regional airflow. Regional transport from nearby metropolitan areas, primarily in southern and central California, occurs in an even more complex structure of airflow in both the horizontal and vertical directions. Adding to this complexity is the limited amount of air quality and meteorological data available along transport pathways.

The Clark County Department of Air Quality and Environmental Management (DAQEM) contracted T&B Systems, Inc. to design and conduct a program to collect data necessary for the characterization and understanding of tropospheric ozone in Clark County. The program is now referred to as the Clark County Regional Ozone and Precursor Study (CCROPS.) The field-monitoring portion of the study was conducted during the 2005 ozone season from May through August.

The program was designed to meet the following objectives:

- Obtain a set of meteorological and air quality measurements that will increase our understanding of the origin of high ambient ozone and precursor levels in Clark County.
- Determine if the current Clark County air quality and meteorological network is adequate to define the regional peak ozone concentrations.
- Obtain a set of ambient measurements of a known quality that can be used to validate meteorological and air quality numerical models.
- Generate a database that can support current and future SIP development.
- On the basis of what is learned from this ozone study, provide specific recommendations for future research programs to support air quality modeling for ozone.

Overview of the Field Study

Much of the design of the network for the 2005 ozone study was based on analysis of ozone data collected for the period 2000 through 2003, including detailed analysis of ten case studies. This information was summarized during the Clark County Ozone Characterization Study conducted as a prelude to CCROPS.

The surface air quality network was enhanced by the establishment and operations of the following measurements:

- Supplemental ozone monitoring stations. Ten sites were established and operated by T&B Systems that consisted of EPA-designated equivalent ozone analyzers and meteorological sensors that operated continuously over the CCROPS study period.
- Saturation ozone monitoring stations. Thirteen sites, also operated by T&B Systems, consisted of portable battery operated samplers with the data recorded on self-contained data loggers. Because of their unique design, the instruments could be cost-effectively operated in virtually any location. The siting of the saturation ozone network concentrated on locations where ozone was suspected to be high.
- CE-CERT equipped two DAQEM measurement sites with analyzers that specifically measured the ozone precursors NO_y , nitric acid, NO_2 , and peroxyacetyl nitrate (PAN). One site was located near primary emissions (JD Smith), and the other was located generally downwind of primary emissions (Joe Neal).
- Ozone precursors of VOC were measured by DRI Reno. Canisters were exposed at three sites, Jean, Joe Neal, and JD Smith during select periods. Timing of the samples was coordinated with general diurnal activities relating to emissions and chemical reactivity. The Jean site was intended to characterize rural/upwind conditions where as the two urban sites characterized the smog during likely different ozone chemistry phases.

Another major gap in the understanding of the atmospheric processes associated with Las Vegas air quality was due to the absence of measurements of both meteorology and ozone aloft. Filling this gap became a major element in the 2005 field study. Measurements of meteorology and air quality aloft were made using a variety of methods and participants. These included:

- A radar wind profiler and mini-Sodar located at the North Las Vegas airport and operated by DRI continuously during the field study.
- Three standard sodars, capable of measuring winds up to 600 m, located at Jean, Floyd Lamb State Park, and the Las Vegas Speedway and operated by DRI continuously during the field study.
- Balloon-borne measurements of temperature, RH, and winds (rawinsonde) and ozone (ozonesonde) from the North Las Vegas airport obtained by T&B Systems,
- Aircraft measurements of temperature and ozone during select periods made by T&B Systems.
- Rawinsondes at Jean during select periods made by NOAA/SORD.
- Winds aloft (pibal) measurements in the foothills of the Las Vegas Valley during select periods made by NOAA/SORD.

The following three-tiered field monitoring effort was developed to maximize the effectiveness of study resources.

- Supplemental air quality and meteorological monitoring, including ten surface ozone and meteorological monitoring sites, two NO_y monitoring sites, and four upper-air monitoring sodars and a radar wind profiler. This monitoring occurred continuously from May 15 through August 31, 2005.

- Intensive Operational Period (IOP) monitoring, consisting of continuous saturation ozone measurements at up to 13 locations and rawinsonde measurements at one location. These measurements were conducted during six “windows of opportunity” when conditions for ozone concentrations were predicted to be good for an extended period of time.
- Episodic monitoring, consisting of ozonesondes at one location, VOC sampling at three locations, and some additional balloon meteorological measurements at various locations. These were two to three day periods that were imbedded within the IOP monitoring effort, when ozone concentrations were predicted to be near or above the Federal 8-hour standard of 85 ppb.

Table E-1 summarizes the three-tier and the CCROPS measurements.

Table E-1. Three-Tier and CCROPS Measurements

Period of Operation	Measureables
Entire study period (May 15 – August 31)	<ul style="list-style-type: none"> • Continuous ozone and meteorology at 10 additional sites • Continuous upper-air meteorology at 4 sites (3 sodar, 1 radar profiler/sodar) • Continuous NO_y, PAN, Nitric Acid measurements at 2 sites
Intensive Operational Periods (four 1- to 2-week periods of potential high ozone conditions)	<ul style="list-style-type: none"> • Upper-air meteorology using rawinsondes at 1 site • Continuous ozone using portable samplers at 13 saturation sites
Episodic Operations (1- to 3-day periods of forecasted high ozone imbedded within IOPs).	<ul style="list-style-type: none"> • VOC samples at 3 sites (up to 4 samples per day) • Upper-air ozone measurements using ozonesondes at 1 site (6 AM, 10 AM, 4 PM) • Upper-air ozone measurements using aircraft/glider (typically 6 AM and 10 AM) • Pibal and rawinsonde measurements at various sites throughout western Clark County

Results and Recommendations

The field-monitoring phase of the program was conducted during May through August 2005. The complete surface monitoring network and balloon-borne upper-air measurements were completely functional by May 15. The sodars and radar wind profiler were phased in as the equipment was installed and became operational.

The IOP and episodic levels of monitoring efforts were distributed throughout the ozone season as originally intended. The plan was to include a representative set of meteorological conditions during which high ozone levels are experienced in Clark County. Episodic-mode field activity was thereby based on high ozone levels being forecast while the IOPs were ongoing, and the field crews were already deployed in the field. As it turned out, IOP operations occurred on 38

days over the following 6 periods. The late August IOPs were an attempt to capture a solid “interbasin transport” high ozone case.

- May 15-16 (intended as a “shakedown period” as well)
- May 23-29
- June 20-July 2
- July 11- 21 July
- August 21-22
- August 27-29

Embedded in these IOPs were a total of 15 episodic days. Nine of these days occurred during June and July, consistent with historical observations indicating that peak ozone activity in Clark County occurred during June and July.

Consistent with the Characterization Study, maximum ozone levels in Clark County during the 2005 field study generally occurred in the northwest quadrant of the Las Vegas Valley. However, on nine of the twelve exceedance-days, the maximum occurred outside the area covered by the DAQEM network. The Paiute Reservation site and Indian Springs, both Supplemental sites and further upvalley from Lone Mountain and Joe Neal, usually measured the highest ozone.

A descriptive analysis of each of the exceedance periods is provided in the main body of this report with the principal goal of determining whether they were transport or locally driven. **Table E-2** summarizes the 2005 exceedances and the results from the analysis. The number of exceedances of the 8-hr ozone standard, if any, and the maximum ozone level is given for the routine DAQEM network, the supplemental network, the saturation network, and for all sites in the CCROPS network. The location of the CCROPS network maximum is given as well. Based on the preliminary analyses and the CART model classification, each exceedance day was classified as primarily due to local sources or interbasin transport. The designation of “transport” versus “local” is, of course, one of relative distinction. All days will likely have some transport component and some local contribution component.

The exceedances on July 2 and July 18 are discussed in more detail, as they are classic examples of a transport scenario and local contribution scenario, respectively. On July 2, Jean was the only DAQEM site to report an exceedance. With southwest winds dominating during the exceedance, Jean was upwind of Las Vegas and thus the background levels were not associated with the Las Vegas urban plume. The California deserts had experienced high ozone levels the previous day. On July 18, air-mass trajectories indicated an extremely stagnant air mass precluding interbasin transport as an important contribution to the large number of exceedances that were experienced (13 sites). The peak ozone level at Jean was only 67 ppb.

Table E-2. Summary of 2005 Ozone Exceedances

Date	DAQEM Network		Supplemental Network		Saturation Network		CCROPS Network		Location of Maximum Ozone	Local or Transport Driven Consensus*
	Max 8-hr Avg ppb	Number Sites Exceeded	Max 8-hr Avg ppb	Number Sites Exceeded	Max 8-hr Avg ppb	Number Sites Exceeded	Max 8-hr Avg ppb	Number Sites Exceeded		
12-Jun	90	3	89	1			90	4	Lone Mtn	Local
29-Jun	101	12	102	7	122	9	122	28	Paiute Res	Local
30-Jun	105	11	108	8	129	10	129	29	Paiute Res	Local
1-Jul	81	0	88	1	99	3	99	4	Indian Sprgs	Both
2-Jul	85	1	91	2	90	4	91	7	Indian Sprgs	Transport
3-Jul	87	1	88	2	80	0	88	3	Paiute Res	Transport
6-Jul	82	0	85	1			85	1	Black Mtn	Both
8-Jul	86	1	87	2			87	3	Paiute Res	Both
15-Jul	87	4	90	1		3	94	8	Paiute Res	Local
18-Jul	95	5	90	2	105	6	105	13	Lone Mtn	Local
6-Aug	87	2	84	0			87	2	Lone Mtn	Local
10-Aug	78	0	88	1			88	1	Paiute Res	Local

* Consensus of preliminary analyses and CART model

Based on initial analyses of the CCROPS data, recommended monitoring network changes and enhancements are the following:

- The Ozone Characterization Study revealed that ozone data from City Center was being impacted by emissions from an adjacent major highway. This was supported by the 2005 field study measurements. Indeed, the site does not currently meet EPA siting criteria for ozone due to its proximity to the highway. Moreover, the analysis indicated it is not representative of regional ozone concentrations, with low daytime readings due to titration by NO from vehicles on the nearby freeway. For these reasons, it is recommended that ozone monitoring be terminated at City Center as it does not provide useful information regarding community health impacts. Data from the nearby JD Smith site appear to adequately represent this area.
- A permanent site at Paiute should be installed to ensure that peak ozone exposure in Clark County is measured.
- A permanent site at Indian Springs should be installed to further define the northwest extent of high ozone levels. Moreover, as growth and development continues to expand in the Valley, the ozone peak could conceivably shift further northwest.
- A temporary monitoring site near McCarran Airport in the Sunset Park area should be operated during the upcoming ozone season to further investigate the possibility of high ozone concentrations in that area.

In addition, the following monitoring should be considered:

- An additional ozone site in the foothills to the northwest of Las Vegas. The saturation network showed the urban ozone plume extending well into the foothill region. While the Lone Mountain site does a fairly good job of representing the area, an additional site may be warranted, especially as the area demographics changes. For example, housing developments are already extending to the Red Rock Canyon boundary. Kyle Canyon development and regions in between will likely follow.
- Additional monitoring in the Craig Ranch area for similar reasons noted above. Temporary monitoring should initially be considered to confirm the results obtained by the saturation network.
- To determine the importance of ozone aloft at night and early morning, and to aid in the daily ozone forecasts, monitoring could be conducted at one of the two CCROPS ridgetop sites. Based on preliminary analyses, both the Black Mountain and Lower

Potosi sites did a good job of producing measurements representative of ozone concentrations aloft. However, the Black Mountain site is considerably closer to the DAQEM offices, and would therefore be easier to service.

To further enhance the understanding of the ozone issues we recommend the following additional analyses of the data collected during the 2005 study:

- Select periods from the 2005 field study for detailed analyses and as candidates for DAQEM's numerical modeling based on 1) the quality and extent of measured data, 2) initial indications of the contributions from interbasin transport and/or local sources, and 3) representativeness. Detailed descriptive analyses should be performed of the 3-dimensional wind field using all sonde, sodar, and profiler measurements. The growth and decay of the surface boundary layer evaluated, and the characteristics of ozone and precursors both at the surface and aloft should be determined.
- From the periods selected for detailed analyses and modeling, determine what features are critical to ozone processes. Compare these features with MM5 and ozone model outputs.
- Examine the hourly timing of peak ozone within the extended network. Characterize with respect to the 'conceptual model' developed from the detailed episode analysis.
- Using the entire data set, including aircraft measurements, quantify the contribution by the Las Vegas urban area to ozone concentrations under different meteorological scenarios.
- Integrate the ozone, VOC and NO_y data to determine extent of reaction and what information can be extracted regarding major sources.
- Examine the meteorological and air quality measurements at locations such as Moapa, Meadview, Mesquite, and western Utah for downwind impacts.
- Examine in more detail interbasin transport routes (e.g., Coachella Valley in the south and Antelope Valley in the north of the SoCAB, and Tehachapi Pass for San Joaquin Valley).
- Investigate in greater detail the effect that wildfires have on ozone formation. Determine the extent of the smoke plume using existing PM and NO_y data.
- Update and refine the existing CART model and forecasting protocol.

TABLE OF CONTENTS

<u>Section</u>	<u>Page</u>
ACKNOWLEDGEMENTS	ii
EXECUTIVE SUMMARY	ES-1
LIST OF FIGURES	iv
LIST OF TABLES	v
1. INTRODUCTION.....	1-1
1.1 Overview of the Study Design	1-1
1.2 Overview of the Field Activities	1-3
1.3 Content of This Report.....	1-3
2. SAMPLING NETWORK.....	2-1
2.1 Overview of Network Components.....	2-1
2.2 DAQEM	2-2
2.3 T&B Systems	2-8
2.3.1 Surface Ozone Measurements.....	2-8
2.3.2 Rawinsondes and Ozonesondes	2-11
2.3.3 Aircraft Measurements	2-11
2.4 DRI South (Las Vegas) /NOAA	2-11
2.5 UCR/CE-CERT	2-12
2.6 DRI North (Reno).....	2-12
3. MEASUREMENT METHODS.....	3-1
3.1 Meteorological Measurements	3-1
3.1.1 Surface Wind Speed and Direction.....	3-1
3.1.2 Radar Wind Profiler	3-1
3.1.3 Sodars.....	3-2
3.1.4 Rawinsonde Systems	3-4
3.2 Air Quality Measurements.....	3-5
3.2.1 Ozone	3-5
3.2.2 NO _y / PAN Measurements.....	3-10
3.2.3 VOC Measurements.....	3-12
4. FIELD PROGRAM.....	4-1
4.1 Basic Elements	4-1
4.2 Operations Summary	4-2
4.3 Meteorological Conditions.....	4-3
5. QUALITY ASSURANCE AND DATA VALIDATION	5-1
5.1 Project Plan	5-1
5.2 Quality Assurance/Quality Control Documentation.....	5-1
5.3 Data Validation	5-2
6 DATABASE DESIGN.....	6-1
7. SUMMARY OF THE OBSERVATIONS (DESCRIPTIVE ANALYSIS)	7-1
7.1 High Ozone Events – 2005	7-1
7.2 Saturation Network	7-4
7.3 Summary of Exceedances	7-7
7.4 Wild Fire Events	7-16
7.5 Forecasting Ozone in Clark County.....	7-19
7.6 Adequacy of the DAQEM Ozone Measurement Network	7-20

TABLE OF CONTENTS

<u>Section</u>		<u>Page</u>
7.	<i>SUMMARY OF THE OBSERVATIONS (DESCRIPTIVE ANALYSIS) continued</i>	
7.7	Ozone Precursor Measurements	7-31
	7.7.1 NO _y	7-31
	7.7.2 VOC Measurements	7-36
7.8	Balloon-borne Measurements	7-36
7.9	Aircraft Measurements	7-41
8.	RECOMMENDATIONS	8-1
8.1	Recommended Monitoring Network Changes and Enhancements.....	8-1
8.2	Recommended Additional Analyses.....	8-2

LIST OF FIGURES

<u>Figure</u>		<u>Page</u>
1-1	Existing DAQEM Monitoring Network, Showing Number of Exceedances 2000 – 2003....	1-2
2-1	Project Organization and Responsibilities.....	2-1
2-2	CCROPS Surface Ozone Monitoring Network Coverage in Clark County.....	2-3
2-3	CCROPS Surface Ozone Monitoring Network Coverage in Las Vegas Valley.....	2-4
2-4	CCROPS Precursor Monitoring Network	2-5
2-5	CCROPS Upper-Air Monitoring Network	2-6
3-1	Comparison of Saturation Sampler Versus SCAQMD Ozone Data at the Santa Clarita Site in 2003.....	3-7
3-2	Sampler Mounting at Ground Level with the Sample Inlet at the Top of the Pole.....	3-8
3-3	Sampler Mounting on a Utility Pole	3-8
3-4	Sailplane with Tow Aircraft Readied for Launch.....	3-9
3-5	Sampler Mounting in Glider with Cowling Removed	3-9
3-6	Sampler Mounting in Back Seat of Tow Aircraft.....	3-9
3-7	Schematic Diagram of NO _y Analyzer Configuration	3-11
3-8	Schematic Diagram of NO ₂ /PAN Gas Chromatograph.....	3-12
7-1	DAQEM and Supplemental Networks Daily Peak 8-hr Ozone Concentration.....	7-3
7-2	Maximum 8-hr Ozone Contours for June 1 at All Sites	7-5
7-3	Maximum 8-hr Ozone Contours-Without Sunset Park	7-6
7-4	Maximum 8-hr Ozone Levels for July 2.....	7-11
7-5	Back-Trajectory Analysis for July 2.....	7-12
7-6	July 2, 6 AM Ozonesonde.....	7-13
7-7	July 2, 10 AM Ozonesonde.....	7-13
7-8	Back-Trajectory Analysis for July 18.....	7-14
7-9	Maximum 8-hr Ozone Levels for July 15.....	7-15
7-10	NOAA Smoke Forecast for Afternoon of June 29	7-16
7-11	Maximum 8-hr Ozone Levels on June 30	7-17
7-12	Ozone Profile for Morning of June 23 Near Goodsprings Fire.....	7-18
7-13	Ozone and PM ₁₀ Profile for Morning of July 1	7-19
7-14	Maximum 8-hr Ozone Levels-Only DAQEM Sites.....	7-21
7-15	Maximum 8-hr Ozone Levels for July 18 at Both DAQEM and Supplemental Sites	7-22
7-16	Maximum 8-hr Ozone Levels for July 15 at Both DAQEM and Supplemental Sites	7-23
7-17	Maximum 8-hr Ozone Levels for July 15 at All CCROPS Sites Including Saturation Sites	7-24
7-18	Composite Representation of Relative Ozone Concentration During IOPs	7-25
7-19	Wind Rose Diagram for Sloan	7-26
7-20	Comparison of Daily Maximum Ozone at Jean and Sloan	7-27
7-21	Time-Series Plot Showing Relationship Between Ridgetop and Valley Sites.....	7-28
7-22	Example of Ozonesonde Data Showing Morning Inversion at 1000 m.....	7-29
7-23	Ozone at Ridgetop Sites Compared with NLV Ozonesonde	7-30

LIST OF FIGURES

<u>Figure</u>		<u>Page</u>
7-24	Plot of Nitric Acid for August 2005 at Joe Neal Site	7-33
7-25	Plot of Nitric Acid and Ozone for August 12, 2005 at Joe Neal Site	7-34
7-26	Comparison of NO ₂ Determined by Chemiluminescence (CL) and Gas Chromatography (GC) at Joe Neal Site in August 2005.....	7-34
7-27	Plot of Nitric Acid for August 2005 at JD Smith Site	7-35
7-28	Plot of Nitric Acid and Ozone for August 12, 2005 at JD Smith Site.....	7-35
7-29	Comparison of NO ₂ Determined by Chemiluminescence (CL) and Gas Chromatography (GC) at JD Smith Site in August 2005	7-36
7-30	Ozonesonde Soundings at NLV on July 1, 2005.....	7-39
7-31	Comparison of NLV and Desert Rock Soundings	7-40
7-32	Results of Comparison Flight Between Glider and Tow Ozone Samplers.....	7-42
7-33	Results of Audit of Tow Aircraft Sampler	7-42
7-34	Maximum AQI for July 1, 2005	7-43
7-35	Maximum 1-Hr Ozone Concentrations for July 1, 2005.....	7-43
7-36	Maximum AQI for July 2, 2005, the Day of the Exceedance at Jean.....	7-44
7-37	Maximum 1-Hr Ozone Concentrations for July 2, 2005.....	7-44
7-38	Four Soundings Showing the Progression of the Mixing of Ozone to the Surface.....	7-45
7-39	Aircraft Flight Observations of Ozone on August 21	7-46
7-40	Aircraft Flight Observations of Ozone on August 22	7-47
7-41	Aircraft Flight Observations of Ozone on August 27	7-48
7-42	Aircraft Flight Observations of Ozone on August 28	7-49
7-43	Aircraft Flight Observations of Ozone on August 29	7-50

LIST OF TABLES

<u>Table</u>		<u>Page</u>
2-1	Summary of DAQEM Site Locations	2-7
2-2	Summary of Supplemental Site Locations	2-9
2-3	Summary of Saturation Site Locations.....	2-10
4-1	CCROPS Measurements.....	4-1
4-2	Network Operational Status and Daily Summaries	4-8
6-1	Data Flags.....	6-1
7-1	Number of Days When Peak 8-hr Ozone was Greater Than or Equal to 85 ppb.....	7-2
7-2	Comparison of Concentrations Versus Sunset Park	7-6
7-3	Summary of 2005 Ozone 8-hr Exceedances	7-9
7-4	Mean Concentrations of Nitrogenous Species in 2005 at Joe Neal and JD Smith Air Quality Monitoring Sites	7-33
7-5	Rawinsonde/Ozonesonde Schedule at NLV	7-37

1. INTRODUCTION

During the last two and a half decades, the Las Vegas Valley has emerged as one of the fastest growing metropolitan areas in the nation, leading to increased emissions into the atmosphere that are precursors to ozone production. In recent years, concentrations of ozone in Clark County have approached, and on occasion exceeded, the new 8-hr ambient air quality standard as defined by the recently adopted Federal Ozone Standard. These exceedances increase the potential for a violation of the federally mandated Clean Air Act, and the necessity for developing control strategies. Planning realistic, cost effective control strategies requires a comprehensive understanding of the origin and fate of ozone and ozone precursors. Characterizing ozone in Clark County and the Las Vegas Valley is a challenging process. Local airflow is a complex diurnal cycle resulting from mountain and valley dynamic influences when the area is under high-pressure weather systems that suppress regional airflow. Regional transport from nearby metropolitan areas, primarily in southern and central California, occurs in an even more complex structure of airflow in both the horizontal and vertical directions. Adding to this complexity is the limited amount of air quality and meteorological data available along transport pathways.

The Clark County Department of Air Quality Management (DAQEM) contracted T&B Systems, Inc. to design and conduct a program to collect data necessary for the characterization and understanding of tropospheric ozone in Clark County. The program is now referred to as the Clark County Regional Ozone and Precursor Study or CCROPS. The field-monitoring portion of the study was conducted during the 2005 ozone season from May through August.

The program was designed to meet the following objectives:

- Obtain a set of meteorological and air quality measurements that will increase our understanding of the origin of high ambient ozone and precursor levels in Clark County.
- Determine if the current Clark County air quality and meteorological network is adequate to define the regional peak ozone concentrations.
- Obtain a set of ambient measurements of a known quality that can be used to validate meteorological and air quality numerical models.
- Generate a database that can support current and future SIP development.
- On the basis of what is learned from this ozone study, provide specific recommendations on future research programs to support air quality modeling for ozone.

1.1 Overview of the Study Design

Much of the design of the network for the 2005 ozone study is based on analysis of ozone data collected for the period 2000 through 2003, including detailed analysis of ten case studies. This information was summarized during the Clark County Ozone Characterization Study¹ (Lehrman et al, 2005) conducted as a prelude to CCROPS. Generally, on the days examined, the afternoon surface winds in the Las Vegas Valley (Valley) supported transport of the Las Vegas urban plume to the northwest. The prevailing-winds trajectory initially moved early morning urban emissions to the southeast under a terrain-induced drainage flow but reversed as the drainage winds diminished and were replaced by an upvalley flow. This provided a recirculation

¹ Lehrman D, D Bush, W Knuth, C Blanchard; Ozone Characterization Study; Final Report to Clark County Department of Air Quality & Environmental Management; by T&B Systems, Santa Rosa, CA; January, 2006.

back through the center of the city, possibly adding to the ozone precursors and ultimately increased the urban plume ozone. Superimposed on the locally generated ambient ozone are potentially high background ozone levels due to interbasin transport from the population centers in southern and central California. Instances of overwhelming transport were observed in the analyses of prior events.

The prevailing peak ozone levels in the northwest portion of the Valley is demonstrated by reviewing the spatial distribution of 8-hr exceedances over the last few years. **Figure 1-1** is a map showing the location of the DAQEM ozone monitoring sites and the number of ozone exceedances recorded at each of the sites for the period 2000 through 2003. The dominance of exceedances in the northwest and western sections of the Valley is clearly demonstrated. The only other site that shows a significant number of exceedances is Jean, located southwest of the Las Vegas urban area.

On the basis of the data analyzed, a monitoring network was designed for 2005 to fill in gaps between existing monitors and make measurements in regions that are suspected of having high ozone concentrations, as well as to measure boundary-layer air quality and meteorology above the ground surface.

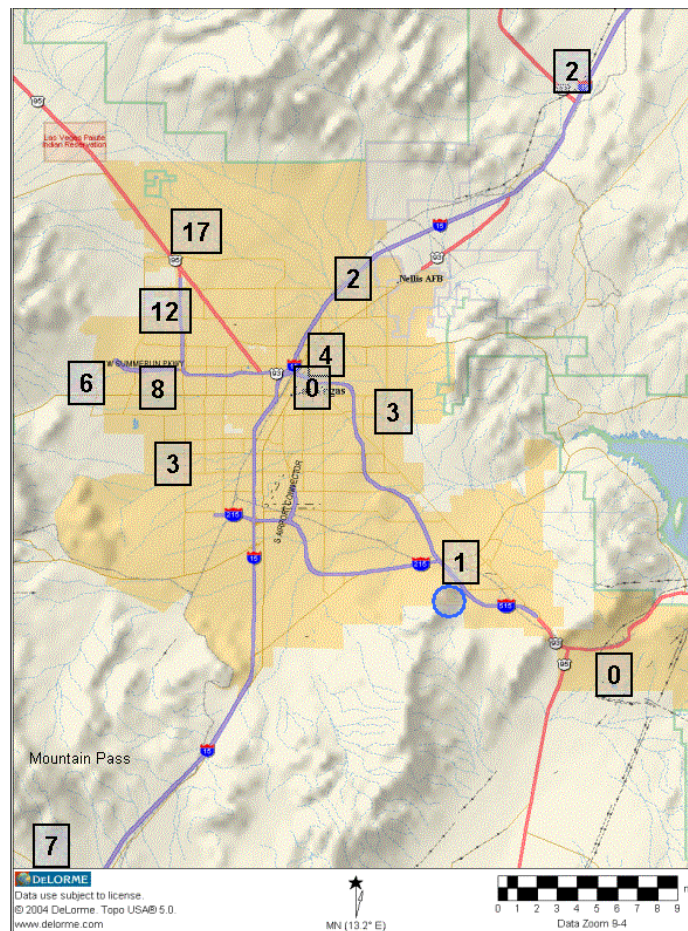

Figure 1-1. Existing DAQEM Monitoring Network, Showing Number of Exceedances 2000 – 2003

1.2 Overview of the Field Activities

The CCROPS 2005 monitoring program was conducted during May through August, and consisted of the following new and existing elements:

- DAQEM Monitoring – Ozone, NO_x, and meteorology at existing sites operated by Clark County. .
- Saturation Ozone -- Sites to collect ozone data during select periods ranging over the ozone season. These employed portable, battery operated samplers (12 sites)
- Supplemental Ozone -- Continuous FRM monitors operated for the duration of the ozone season (10 sites May through August). This network of sites extended from Indian Springs in the north to Searchlight in the south, with collocated meteorological measurements. Two sites were located on top of prominent peaks to measure ozone aloft.
- Upper Air – Aircraft measurements (2 airborne platforms), remote sensing of winds at 4 sites, 2 rawinsonde sites, 1 ozonesonde site and 1 pibal site.
- Nitrogen Species (NO_y, PAN, etc.) -- Measurements added to existing DAQEM sites at J.D. Smith and Joe Neal
- Volatile Organic Compounds (VOC) -- Measurements added to existing DAQEM sites at Jean, J.D. Smith and Joe Neal
- Enhanced NO_x -- Added to the Joe Neal site

In addition to the DAQEM monitoring, continuous supplemental ozone, nitrogen species, and remote wind sensing measurements were conducted throughout the entire study period. The remaining measurements were conducted using an established protocol during periods of anticipated high ozone concentrations in order to best utilize project resources.

1.3 Content of This Report

This report consists of seven main sections in addition to this introduction. In Section 2, the study design and subsequent CCROPS monitoring network are discussed, including detailed maps of the locations of all of the study-specific measurements. The overall organization of the study is also discussed. Details regarding the monitoring methodologies used during the study are presented in Section 3. Section 4 presents a discussion of the field activities during the CCROPS monitoring conducted in the summer of 2005. This includes a summary of weather conditions during the study, and specifics regarding monitoring for each day of the study. A discussion of the quality assurance employed for the study is contained in Section 5. Section 6 discusses the CCROPS database development, and presents specifics regarding the structure of the delivered database. Section 7 contains results from initial analyses of the CCROPS data. These analyses address such questions as the adequacy of the existing DAQEM ozone monitoring network, the role of both transport and local contributions in producing exceedances of the ozone standard, the role ozone concentration aloft play in the Las Vega Valley, and the role that wildfires had on ozone in Clark County. Finally, recommendations for enhancing the DAQEM monitoring network and for additional analyses are provided in Section 8.

2. SAMPLING NETWORK

2.1 Overview of Network Components

Because of its extensive nature, the CCROPS field monitoring effort involved a coordinated and cooperative effort from a number of participants. Figure 2-1 shows the project organization for CCROPS, and the role that each participant had in the overall monitoring effort. This section describes each of these monitoring efforts in more detail.

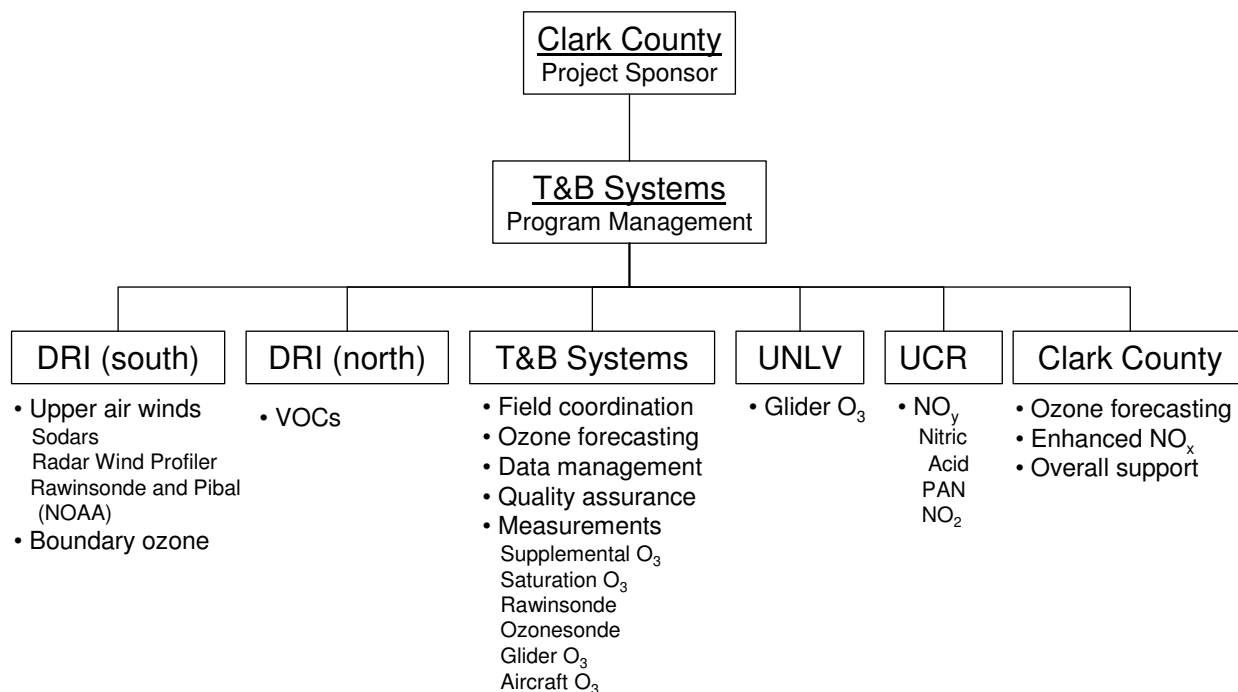

Figure 2-1. Project Organization and Responsibilities

Surface-based measurements established and operated specifically for this project consisted of ozone, oxides of nitrogen (NO_y), Volatile Organic Compounds (VOC), and meteorology (winds). The charts on Figures 2-2, 2-3, and 2-4 show the locations of surface observations.

A major gap in the understanding of the atmospheric processes associated with Las Vegas air quality was due to the absence of measurements both meteorology and ozone aloft. Filling this gap became a major element in the 2005 field study. Measurements of meteorology and air quality aloft were made using a variety of methods and participants. These include:

- A radar wind profiler and mini-Sodar located at the North Las Vegas Airport and operated by DRI continuously during the field study,
- Three standard Sodars, capable of measuring winds up to 600 m, located at Jean, Floyd Lamb State Park, and the Speedway and operated by DRI continuously during the field study,

- Balloon-borne measurements of temperature, RH, and winds (rawinsonde) and ozone (ozonesonde) from the North Las Vegas Airport during intensive operation- and episode-mode operations by T&B Systems,
- Aircraft measurements of temperature and ozone during select periods by T&B Systems,
- Rawinsondes at Jean during episode-mode operations by NOAA/SORD, and
- Winds aloft (pibal) measurements in the foothills of the Las Vegas Valley during episode-mode operations by NOAA/SORD.

Figure 2-5 shows the locations of the upper air measurements including the special pibals conducted by NOAA/SORD. Aircraft sampling routes and patterns are discussed in detail in Section 7.

2.2 DAQEM

In addition to providing the overall project oversight, the DAQEM meteorologist collaborated with T&B Systems meteorologists in daily operational forecasting for project activities. The Monitoring section of the Clark County Department of Air Quality and Environmental Management (DAQEM) operates air quality monitoring instruments to continuously measure ambient concentrations of pollutants. This includes an existing network of 15 ozone monitors and corresponding surface (10m) winds. The station locations are based on such factors as population exposure and highest likely air pollution concentrations. The locations of the established DAQEM ozone measurements are shown in Figures 2-2 and 2-3. Specific details regarding their location are provided in Table 2-1.

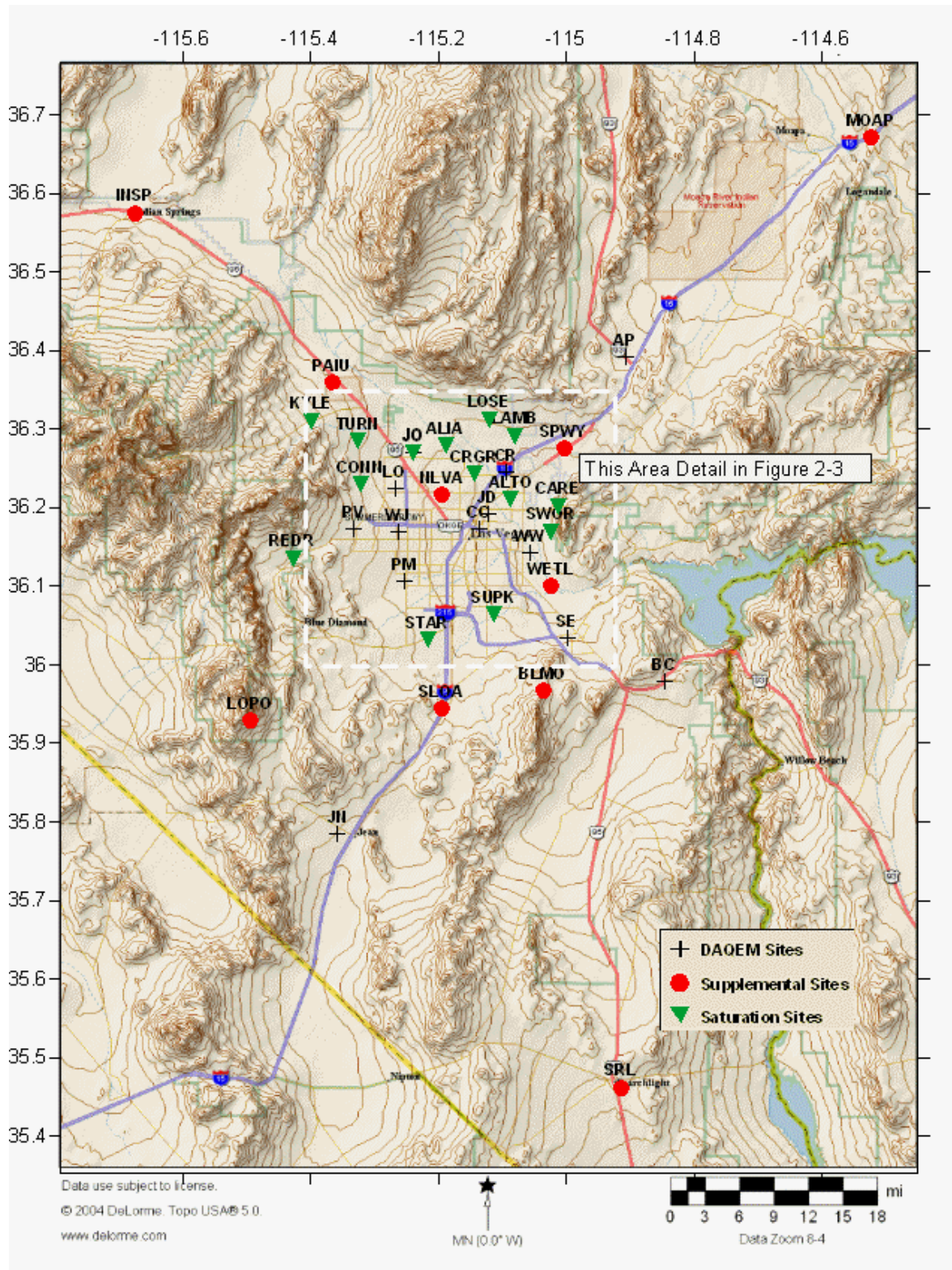

Figure 2-2. CCROPS Surface Ozone Monitoring Network Coverage in Clark County

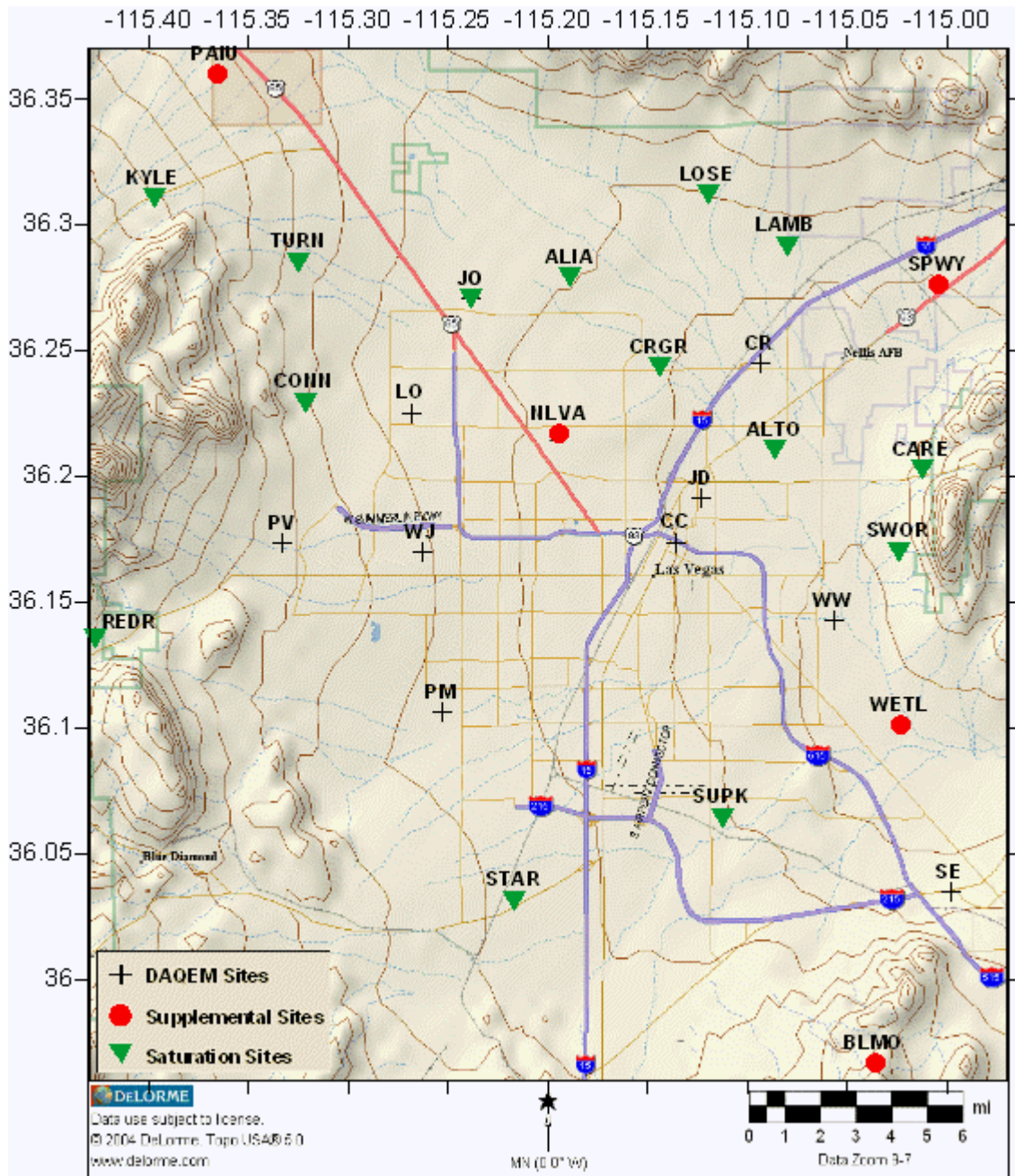

Figure 2-3. CCROPS Surface Ozone Monitoring Network Coverage in Las Vegas Valley



Data use subject to license.
 © 2004 DeLorme. Topo USA® 5.0
 www.delorme.com

★
 ↑
 MN (0.0° W)

0 3 6 9 12 15 18 mi
 Data Zoom 8-4

Supplemental Precursor Monitoring Network - CCROPS 2005

Figure 2-4. CCROPS Precursor Monitoring Network

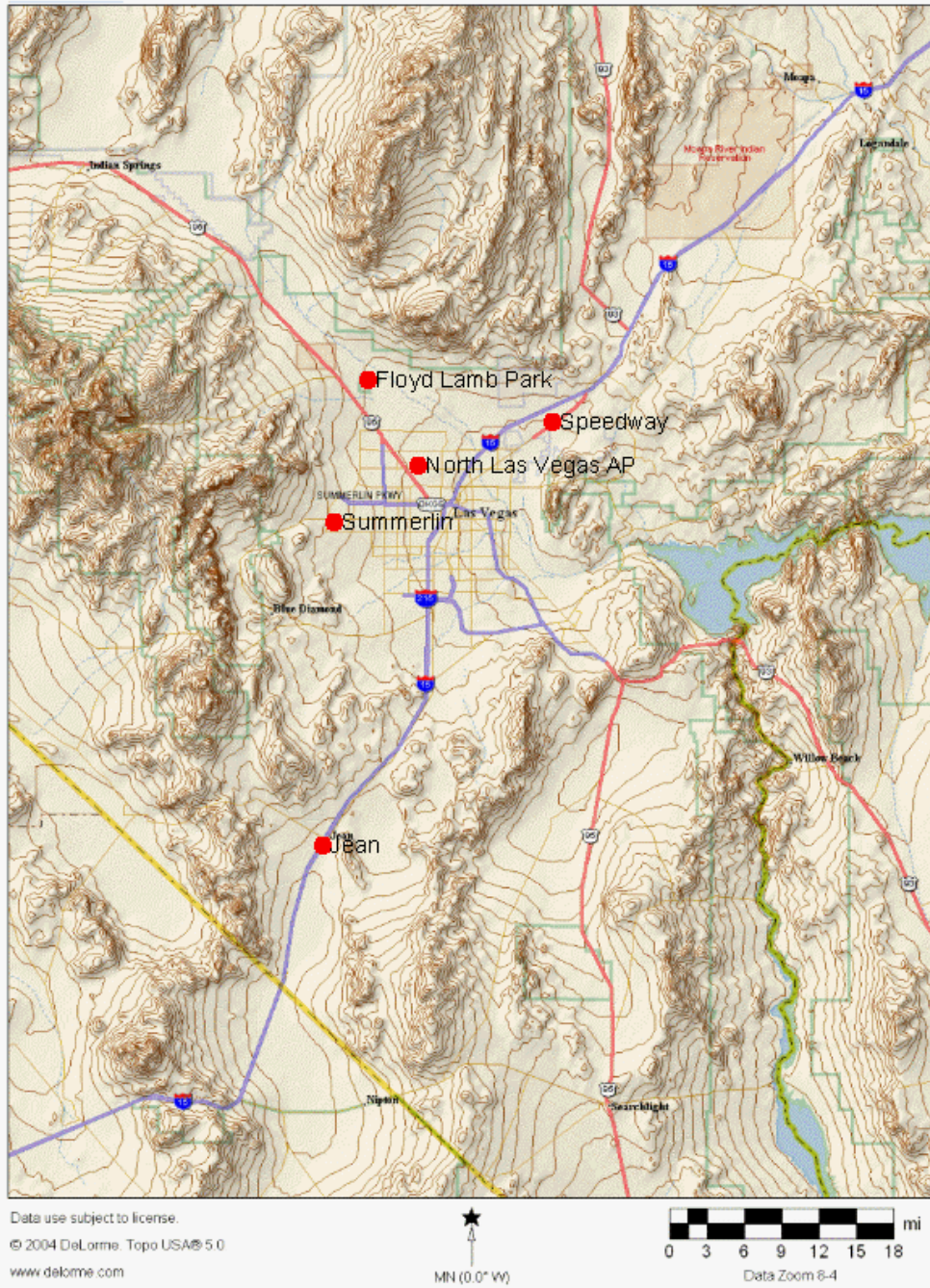

Supplemental Upper Air Monitoring Network - CCROPS 2005

Figure 2-5. CCROPS Upper-Air Monitoring Network

Table 2-1. Summary of DAQEM Site Locations

Site Designation	Location
AP - Apex Lat: 36.3910 Lon: -114.9075 Alt: 659 m	I-15 and US93
BC – Boulder City Lat: 35.9781 Lon: -114.8463 Alt: 758 m	Industrial and US93
CC – City Center Lat: 36.1738 Lon: -115.1358 Alt: 607 m	Bonanza Road and 7 th St.
CR – E. Craig Road (Bemis) Lat: 36.2452 Lon: -115.0932 Alt: 583 m	Craig Rd. and I-15
JD – JD Smith Lat: 36.1912 Lon: -115.1229 Alt: 568 m	Bruce St. and Tonapah Ave.
JN – Jean Lat: 35.7857 Lon: -115.3572 Alt: 921 m	Jean, NV
JO – Joe Neal Lat: 36.2706 Lon: -115.2382 Alt: 710 m	Tropical Pkwy and Rebecca Rd.
LO – Loan Mountain Lat: 36.2252 Lon: -115.2680 Alt: 725 m	W. Gowan Rd. and Buffalo Dr.
MQ – Mesquite Lat: 36.8079 Lon: -114.0609 Alt: 488 m	Old Mill Rd. and Mimosa Way
PL – Henderson (SE Valley) Lat: 36.0289 Lon: -114.9889 Alt: 795 m	W. Lake Mead Dr. and Van Wagenen
PM – Paul Meyer Lat: 36.1064 Lon: -115.2532 Alt: 731 m	W. Flamingo Rd. and Tenaya Way
PV – Palo Verde Lat: 36.1734 Lon: -115.3327 Alt: 930 m	W. Alta Dr. and Pavillion Center Dr.
WJ – Walter Johnson Lat: 36.1698 Lon: -115.2630 Alt: 769 m	W. Alta Dr. and Buffalo Dr.
WW – Winterwood Lat: 36.1429 Lon: -115.0563 Alt: 523 m	E. Sahara Ave. and Winterwood Blvd.

2.3 T&B Systems

2.3.1 Surface Ozone Measurements

Much of the design of the surface ozone measurement network for the CCROPS is based on analysis of ozone data collected for the period 2000 through 2003 during the Clark County Ozone Characterization Study¹, including a detailed analysis of ten case studies. Generally the afternoon surface winds in the Valley supported transport of the Las Vegas urban plume to the northwest on study days. The prevailing-winds trajectory initially moves to the southeast under drainage flow but reverses as drainage winds diminish. This provides a recirculation back through the center of the city, possibly adding to the ozone precursors and ultimately increasing the urban plume ozone as it moves to the northwest.

On the basis of the data analyzed, a monitoring network was designed to fill in regions between existing DAQEM monitors and make measurements in regions that may be suspected of having elevated ozone levels. Additional surface ozone measurements conducted by T&B Systems consisted of the following types:

- Supplemental ozone monitoring stations. These sites consisted of EPA-designated equivalent ozone analyzers located at available facilities for the CCROPS study period. Wind speed / wind direction was also collected at each site, typically at about 2 meters above rooftop (2 to 10 meters agl). The supplemental sites were placed at locations that addressed specific issues regarding ozone in Clark County. These included better defining boundary conditions of the region and obtaining more information about background concentrations and nocturnal concentrations above and outside of the urban area.
- Saturation ozone monitoring stations. These sites consisted of portable samplers operated from batteries with the data recorded on self-contained data loggers. Because of the unique design, the samplers could be hung on utility poles or placed at ground level with a sample line extending to a 3-meter sample height. The instruments required no environmental controls so they could be cost-effectively operated in virtually any location. The siting of the saturation ozone network concentrated on locations where ozone was suspected to be high based on a review of the existing data, flow patterns, and the distribution of the major source regions. In addition, samplers were placed in areas currently underrepresented relative to their population. Samplers thus were located primarily in the urbanized area of Las Vegas.

Figures 2-2 and 2-3 show the enhanced CCROPS ozone monitoring network. Tables 2-2 and 2-3 present additional information regarding the locations of the supplemental and saturation measurements, respectively.

Table 2-2. Summary of Supplemental Site Locations

Site Designation	Location	Purpose
BLMO – Black Mountain Lat: 35.9477 Lon: -115.0512 Alt: 1221 m	Located at transmission tower complex in the foothills south of Henderson, south of the end of Eastern Ave	Upwind background concentrations from south, nighttime elevated plume concentrations
INSP – Indian Springs Lat: 36.5693 Lon: -115.6766 Alt: 975 m	Located at the Indian Springs community center off of US-95, approximately 65 km northwest of Las Vegas	Defining extent of ozone plume northwest of Las Vegas
LOPO – Lower Potosi Lat: 35.8927 Lon: -115.4951 Alt: 1884 m	Located at transmission tower complex on Lower Potosi, approximately 35 km southwest of Las Vegas	Upwind background concentrations from southwest, nighttime elevated plume concentrations
MOAP – Moapa Lat: 36.6718 Lon: -114.5253 Alt: 540 m	Located at BLM fire station off of I-15 approximately 75 km northeast of Las Vegas	Defining extent of ozone plume northeast of Las Vegas
NLVA – North Las Vegas Lat: 36.2170 Lon: -115.1942 Alt: 669 m	Located at the North Las Vegas airport, 4107 W. Cheyenne Ave.	Urban site, area of high concentrations, ozonesonde ground truth
PAIU – Paiute Lat: 36.3577 Lon: -115.3614 Alt: 930 m	Located at a pump house on the Paiute Reservation off of US-95 approximately 25 km northwest of Las Vegas	Potential area of peak concentrations to the northwest of Las Vegas
SLOA – Sloan Lat: 35.9512 Lon: -115.1920 Alt: 991 m	Located at transmission tower complex on a ridge above Sloan, off of I-15 approximately 25 km south of Las Vegas	Placed between Jean and Las Vegas, and located above influence of I-15
SPWY – Speedway Lat: 36.2759 Lon: -115.0032 Alt: 607 m	Located at the Las Vegas Speedway, off of I-15 approximately 15 km northeast of Las Vegas	Possible high concentration to the north-east of Las Vegas
SRLT – Searchlight Lat: 35.4683 Lon: -114.9066 Alt: 1088 m	Located at the Searchlight community center, off of US-95 approximately 80 km south-southeast of Las Vegas	Upwind background concentrations and study boundary site southeast of Las Vegas
WETL – Wetlands Lat: 36.1014 Lon: -115.0230 Alt: 490 m	Located at the Wetlands Park Visitor's Center near the eastern end of Tropicana Ave	Drainage flow along Las Vegas Wash between Las Vegas and Lake Mead
DRAP – Desert Rock Airport Lat: 36.6167 Lon: -116.0017 Alt: m	Located at the Desert Rock Airport	Study boundary site northwest of Las Vegas
MOPR – Mojave Preserve Lat: 35.4169 Lon: -115.6502 Alt: m	Located on the Mojave Wilderness Preserve, CA, off I-15 approximately 80 km southwest of Las Vegas	Study boundary site southwest of Las Vegas

Table 2-3. Summary of Saturation Site Locations

Site Designation	Location	Purpose
ALIA - Aliante Lat: 36.2793 Lon: -115.1885 Alt: 688 m	Aliante Deer Springs Park, in the irrigation pump enclosure at the intersection of Aviary and Deer Springs Rds., Aliante.	Measure possible ozone impact within a suburban setting in the far north-central area of the L.V. Valley, just south of CC215.
ALTO – Alto Lat: 36.2097 Lon: -115.0861 Alt: 557 m	Backyard of a private residence near the intersection of Alto Ave., and Walnut Rd.	Measure possible ozone impact in a residential area in the east-central region of the L.V. Valley, southwest of Nellis AFB.
CARE – Carey Lat: 36.2024 Lon: -115.0122 Alt: 624 m	A Power pole on the south side of Carey Ave., approximately 100 meters east of the Sunrise Terrace sub-division.	Measure possible afternoon upslope ozone transport toward the Sunrise Mountains.
CONN – Conner Lat: 36.2293 Lon: -115.3215 Alt: 839 m	At the south boundary of the Eileen Connors Elementary School, 3810 Shadow Peak Dr., 150 meters south of Alexander.	Measure possible upslope ozone transport south of Lone Mountain, just east of CC215.
CRGR – Craig Ranch Lat: 36.2433 Lon: -115.1433 Alt: 612 m	A Power pole on the east side of Commerce St. across from the Craig Ranch Golf Course, about 200 meters north of Craig Rd.	Measure possible ozone impact in the northeastern area in the gap between the DAQEM Craig site and the N.L.V. airport.
KYLE – Kyle Canyon Lat: 36.3105 Lon: -115.3957 Alt: 1129 m	East edge of private residences at Reymore and Racel Rds., approximately 150 meters north of Kyle Canyon Rd. (Nv-157).	Measure possible upslope ozone transport in the far northwest quadrant of the L.V. Valley.
LAMB – Lamb Lat: 36.2918 Lon: -115.0828 Alt: 648 m	Near the southwest corner of the Nevada Power - Lamb Power Station, 100 meters north of the end of Lamb Bl. at CC215.	Measure possible ozone impact in an open area of future expansion in the north-central portion of the L.V. Valley.
LOSE – Losee Lat: 36.3122 Lon: -115.1195 Alt: 691 m	In a remote undeveloped area about 1.5 km northwest of the end of Losee Rd., north of CC215.	Measure possible ozone impact in an open area of future expansion in the far north-central portion of the L.V. Valley
REDR – Red Rock Lat: 36.1356 Lon: -115.4371 Alt: 1150 m	At the southeast corner of the roof of the two story Visitor Center at the Red Rock Canyon National Conservation Area.	Measure possible upslope or inter/intra-basin ozone transport near the far west edge of the L.V. Valley.
STAR – Star Nursery Lat: 36.0312 Lon: -115.2165 Alt: 737 m	On the perimeter wall at the northwest corner of the Star Nursery, Blue Diamond Rd. and Mohawk St.	Measure possible inter/intra-basin ozone transport in the southwest quadrant of the L.V. Valley.
SUPK – Sunset Park Lat: 36.0640 Lon: -115.1120 Alt: 611 m	A power pole about 100 meters south of the pond and 100 meters east of the Eastern Ave. parking area, Sunset Park.	Measure possible inter/intra-basin ozone transport in the southeast quadrant of the L.V. Valley, SE of McCarran Field.
SWOR – Sword Lat: 36.1699 Lon: -115.0235 Alt: 565 m	Backyard of a private residence SSE of Hollywood Bl., and Bonanza RD.	Measure possible afternoon upslope ozone transport toward the Sunrise Mountains.
TURN – Turner Lat: 36.2734 Lon: -115.3262 Alt: 871 m	Backyard of a private residence, about 0.5 km south of Centennial Pkwy, and 100 meters east of CC215	Measure possible upslope ozone transport north of Lone Mountain, just east of CC215.

2.3.2 Rawinsondes and Ozonesondes

Balloon-borne measurements of temperature, humidity, and winds were made from the T&B Systems facilities at the North Las Vegas airport (Figure 2-3) during IOP-mode operations. Twice-daily soundings were made using GPS wind finding technology that provided one-second data resolution to 6km or more. During so-called episode-mode sampling, operations were ramped to up to include three soundings daily; two of which measured ozone (and associated parameters) as well. Sounding times were coordinated closely to the NOAA Desert Rock routine schedule so they could be compared. On a routine basis, the Desert Rock sounding is the only upper air measurements available in Clark County. An element of this study was to examine how representative the Desert Rock sounding was of conditions in the Las Vegas Valley.

2.3.3 Aircraft Measurements

Characterization of ozone episodes is important in devising effective control strategies to ensure that those strategies work in a variety of conditions corresponding with high measured ozone levels. The transport of ozone/precursors into an area is an important distinguishing characteristic of these episodes. Goals of the CCROPS included obtaining a set of meteorological and air quality measurements that will increase the understanding of the origin of high ambient ozone and precursor levels in Clark County and the determination if the current Clark County measurement network was adequate to define the regional peak ozone concentrations. The reservoir of available ozone upwind of the Las Vegas Valley provides a potentially significant source of both background ozone and precursors that could be transported from upwind locations. A key location in understanding what is being transported into the Las Vegas Valley is the Jean Valley, just upwind. This valley is in the major transport route from areas of the desert southwest that frequently experience elevated ozone levels from air masses passing through the South Coast and San Joaquin Valley Air Basins. The Jean Valley is about a third of the way between the California/Nevada border and Las Vegas and has experienced exceedances of the 8-hr ozone NAAQS, even when the regions within and downwind of the Las Vegas urban area were less than the standard. This makes the Jean region key to the understanding of the drivers causing exceedances in Clark County.

Early in the performance of the CCROPS field study, the potential to use gliders or sailplanes based at the Jean airport was recognized as a sampling platform of opportunity. Through a key connection with the Department of Environmental Studies at University of Nevada, Las Vegas (Dr. Krystyna Stave) and a local soaring association, a research grant and contract support were obtained to add a simple instrument for measuring temperature and ozone profiles from sailplanes. This platform was used to provide ozone and temperature soundings in the Jean Valley during key episode periods of the CCROPS. After initial data were collected and analyzed from the glider platform it became clear that additional valuable information on the spatial distribution of ozone throughout the Las Vegas Valley could be obtained using the glider's tow plane as a cost-effective additional platform for data collection. Thus, an additional instrument was assembled and used in this second aircraft.

2.4 DRI South (Las Vegas) /NOAA

The DRI Las Vegas staff was responsible for establishing and operating remote atmospheric sounding systems. DRI coordinated with NOAA/SORD to make rawinsonde measurements twice daily at Jean during episode-mode monitoring, and special hourly pibal observations close

to the foothills near Summerlin. NOAA rawinsondes also utilized GPS wind-finding equipment. The following sites comprised the DRI/NOAA upper air network:

- North Las Vegas Airport – radar profiler and sodar
- DAQEM monitoring site at Jean – sodar and rawinsondes
- Las Vegas Speedway - sodar
- Floyd Lamb State Park – sodar
- Summerlin - pibals

The combination of these measurements and the North Las Vegas and Desert Rock rawinsondes will provide more information into the three-dimensional regional wind fields than has ever been available and provide the information to initialize and validate MM5 model output during the SIP process.

In addition, DRI operated two surface ozone monitors to measure boundary conditions. Sites were in the Mojave Wildlife Preserve and at Desert Rock.

2.5 UCR/CE-CERT

In order to characterize the ozone chemistry a comprehensive knowledge of nitrogenous species is necessary. Reactive nitrogenous species (NO_y) consists primarily of nitric oxide (NO), nitrogen dioxide (NO_2), peroxyacyl nitrates (PACNs), nitric acid (HNO_3), particulate nitrate, and nitrous acid (HONO) roughly in that order of concentration in ambient photochemical air pollution. Commercial chemiluminescent NO analyzers, such as those currently in use by the DAQEM, are equipped with converters that reduce these NO_2 to NO in order to measure NO_2 concentrations by difference. These converters also reduce other NO_y components thus giving a high bias for the NO_2 concentrations. Because the air stream is filtered, particulate nitrate is not measured. Since the converter (which is integral with the analyzer) resides in a temperature-controlled environment nitric acid is unlikely to penetrate the sampling line effectively. While these lower the NO_2 bias, there is uncertainty in the concentration of NO_y . CE-CERT equipped two DAQEM measurement sites with analyzers that specifically measured NO_y , nitric acid, NO_2 , and peroxyacetyl nitrate (PAN, the most abundant PACN). One site was near primary emissions (JD Smith), and the other is generally downwind of primary emissions (Joe Neal).

2.6 DRI North (Reno)

The DRI Reno staff was responsible for VOC sampling that was conducted concurrent with episode-mode monitoring to provide additional information on ozone precursors. Canisters were exposed at three sites, Jean, Joe Neal, and JD Smith. Two 6-hr integrated samples daily were taken at Jean (beginning at 00 and 06 PDT), and four 3-hr integrated samples daily taken at the latter two sites (beginning at 00, 06, 11, 17 PDT). Timing of the samples was coordinated to general diurnal activities relating to emissions and chemical reactivity. The Jean site was intended to characterize rural/upwind conditions where as the two urban sites characterized the air mass during likely different ozone chemistry phases.

3. MEASUREMENT METHODS

Descriptions of the instrumentation and methods employed in the study specific measurements are provided in this section. The meteorological measurements are discussed first and include both surface and upper air equipment. Upper air measurements were made using a variety of methods ranging from remote sensing instruments to balloon-borne, GPS wind finding systems. The air quality measurements include ozone and ozone precursor monitoring equipment.

3.1 Meteorological Measurements

Surface-based and aloft meteorological measurements comprise the supplemental measurements made for CCROPS. The only project-specific surface measurements were winds. Aloft measurements were made using both remote-sensing wind finding equipment and balloon-borne measurements of temperature, humidity and winds.

3.1.1 Surface Wind Speed and Direction

An RM Young 5103 Wind Monitor or 5305 Wind Monitor-AQ wind speed and direction sensor was used at all T&B supplemental sites. These sensors employ a propeller anemometer. The sensors were mounted on 2-meter tripods, typically on the roof of the saturation site shelter, resulting in measurement heights ranging from 2 to 10 meters. Continuous data were recorded using a Campbell Scientific CR10 data logger.

Accuracy (instrument specifications)	
Horizontal Wind Speed	$\pm(0.2 \text{ m/s} + 5\% \text{ of observed})$
Horizontal Wind Direction	$\pm 5 \text{ degrees}$
Precision (performance checks)	
Horizontal Wind Speed	$\pm 0.1 \text{ m/s}$
Horizontal Wind Direction	$\pm 2 \text{ degrees}$
Output Resolution	
Horizontal Wind Speed	0.1 m/s
Horizontal Wind Direction	1 deg.
Starting Threshold	1.0 m/s

3.1.2 Radar Wind Profiler

The Vaisala LAP®-3000 Lower Atmosphere Wind Profiler was utilized in this study without the associated RASS. This instrument is a Doppler radar that provides vertical profiles of horizontal wind speed and direction, and vertical wind velocity to an altitude of 3 km above ground level. The wind profiler operated at the North Las Vegas airport.

Ray and Daryl – can you provide comparable specs and expanded description

Accuracy (instrument specifications)	
Horizontal Wind Speed Components	
Horizontal Wind Speed	
Vertical Wind Speed Component	
Horizontal Wind Direction	
Output Resolution	
Horizontal Wind Speed Components	
Horizontal Wind Speed Vector	
Vertical Wind Speed Component	
Horizontal Wind Direction	
Sampling Heights	
Sampling Height Increment	
Minimum Sampling Height	
Transmit Frequency	
Averaging and Reporting Interval	

3.1.3 Sodars

Two models of SODARS were utilized in the project: AeroVironment Model 2000 and Model 4000.

Model 2000 SODAR System

At Jean, the Speedway, and Floyd Lamb Park, AeroVironment Model 2000 SODAR systems were installed and operated continuously for the duration of the field study.

The Model 2000 includes the following components: (1) the antenna array and pre-amplification electronics, (2) the acoustic signal processor (ASP) and (3) Pentium based computer user interface. The antenna array consists of three heated parabolic dishes enclosed with 1-2 meter high acoustic enclosures. Thnadners™ are mounted at the top of each enclosure. Thnadners™ are saw-tooth (patented) acoustic devices that optimize the directional performance.

Three-dimensional wind profiles are determined using the data from all three antennae. One antenna is pointed vertically and the other two antennae are orthogonally oriented and positioned at variable zenith angles of up to 30° (nominally). In normal situations the non-vertical antennae are set to a zenith angle of 20°. For precise horizontal wind measurements in complex terrain locations the horizontal wind components are corrected for the actual vertical velocity on a pulse-by-pulse basis. Depending upon the physical characteristics of the site, other operating zenith angles may be used.

The heart of the system is the acoustic signal processor (ASP) unit. It generates the acoustic pulses, tapers (to lengthen the diaphragm lifetime) the pulse, samples the received atmospheric echo at preselected height intervals, transforms these range gated data into the spectral domain, detects the mean frequency shift and translates these data into useful meteorological information.

The ASP is connected to a Pentium microcomputer via a serial communications link that normally operates at 19.2 Kb. The ASP produces three types of data: (1) the wind and wind turbulence information, (2) the time series of the echo intensity from the vertical antenna (called the facsimile data) and (3) troubleshooting information based on the real time examination of the Doppler spectra.

Accuracy (instrument specifications)	
Horizontal Wind Speed Components	0.20 m/s for 2 m/s < WS < 5 m/s (5% for WS > 5 m/s)
Horizontal Wind Speed	0.30 m/s for 2 m/s < WS < 5 m/s (7% for WS > 5 m/s)
Vertical Wind Speed Component	0.10 m/s for W > 0.5 m/s (5% for W > 3 m/s)
Horizontal Wind Direction	3 deg. for WS > 2 m/s
Output Resolution	
Horizontal Wind Speed Components	0.01 m/s
Horizontal Wind Speed Vector	0.01 m/s
Vertical Wind Speed Component	0.01 m/s
Horizontal Wind Direction	1 deg.
Sampling Heights	20
Sampling Height Increment	30 meters
Minimum Sampling Height	20 meters
Transmit Frequency	500 to 6000 Hz.
Averaging and Reporting Interval	Single pulses to 1440 minutes

Model 4000 MiniSODAR System

To complement the radar wind profiler at the North Las Vegas airport, An AeroVironment Model 4000 high-frequency Doppler SODAR system, or MiniSODAR was utilized. This system consists of a compact 32-element phased array antenna to form the three orthogonal beams needed to measure a complete three-dimensional wind profile. In addition to its compact size and minimal power requirements, winds are measured at 5-meter increments and are typically used as a wind tower replacement system —measuring up to 200 meters.

Accuracy (instrument specifications)	
Horizontal Wind Speed	0.5 m/s
Horizontal Wind Direction	±5°
Maximum Altitude	200 meters
Sampling Height Increment	5 meters
Minimum Sampling Height	15 meters
Transmit Frequency	4500 Hz.
Averaging and Reporting Interval	1 to 60 minutes

3.1.4 Rawinsonde Systems

Sippican W-9000 (T&B Systems)

The Sippican W-9000 system consists of a SIPPICAN ZEEMET W-9000 GPS based navaid receiver/data system for measuring winds and the SIPPICAN Mark II Microsondes radiosonde packages.

The SIPPICAN ZEEMET W-9000 receiving station interfaces with a personal computer and printer. This is a state-of-the-art wind finding system employing GPS technology. The UHF receiver operates in the 400 MHZ range. SIPPICAN software enables the interface with the SIPPICAN W-9000 receiver and reduces the thermodynamic pressure, temperature and humidity (PTU) and navaid/wind data. During each flight, the technician is able to monitor both raw and reduced data in near real time. The software also includes graphics and plotting capabilities that allow the technician to review results during and at the end of each flight. Both raw and reduced data were stored on the hard disk in subdirectories identified by the flight name. All data files were copied to both primary and backup diskettes immediately after each flight.

SIPPICAN Mark II Microsondes (T&B Systems)

The SIPPICAN Mark II Microsondes are 10 x 19 x 15 cm and weigh 250 grams with a water-activated 18V battery. The radiosonde UHF transmitter sends its modulated signals in the 400 MHZ range. The Microsondes are calibrated at the factory in a computer-controlled environmental chamber. Calibration coefficients are stored in read-only-memory (ROM) within each sonde and are automatically transmitted to the receiver in 1.5 sec intervals. Temperature is measured using a bead thermistor and relative humidity using a carbon hygistor. The SIPPICAN W-9000 is an automatic wind finding system that is based on tracking the sonde using the GPS satellite network. The Microsonde incorporates a low-noise integrated circuit GPS receiver. Winds aloft are calculated from the change in balloon position (determined from navaid) with time. Height is obtained directly from GPS positioning and, unlike older systems, pressure is now a derived parameter, calculated from the hydrostatic equation, using measured height, temperature, and humidity.

Accuracy (instrument specifications)	
Horizontal Wind Speed	$\pm 0.5 \text{ ms}^{-1}$
Horizontal Wind Direction	unknown
Temperature	$\pm 0.2^\circ \text{ C}$
Relative Humidity	$\pm 2.0\%$
Output Resolution	
Horizontal Wind Speed	0.1 m/s
Horizontal Wind Direction	1.0°
Temperature	0.1° C
Relative Humidity	1.0%

It should be noted here that the EN-SCI Corporation KZ-ECC ozonesonde system was used in conjunction with the SIPPICAN W-9000 Mark II Microsondes radiosonde package at the North Las Vegas airport. This instrument is discussed in Section 3.2.1.3.

Visalia GPS Rawinsonde (NOAA)

Ray and Daryl – to provide comparable specs and description

Pibals (NOAA)

Ray and Daryl – to provide comparable specs and description

3.2 Air Quality Measurements

3.2.1 Ozone

Dasibi Model 1000 series

The supplemental sites were equipped with either Dasibi Model 1003 or Model 1008 UV photometric ozone analyzers (EPA equivalent numbers EQOA-0577-019 and EQOA-0383-056, respectively). Sampling was made through Teflon lines, which, with the exception of the site at the Speedway, were of sufficiently short length to meet EPA requirements for sample residence time. Analyzers were routinely checked using a certified transfer standard, following operating procedures consistent with EPA guidelines. Continuous data were recorded using a Campbell Scientific CR10 data logger. Continuous internal shelter temperature was also recorded at all sites.

Accuracy (performance checks)	±5%
Precision (performance checks)	±5%
Resolution	0.001 ppm
Lower Quantifiable Limit	0.002 ppm

2B Model 202 Ozone Analyzer

The 2B Ozone Monitor was utilized at the Lower Potosi site after a nearby wildfire disrupted commercial power for an extended period. In addition, 2B monitors were used at the boundary sites at Mountain Pass and Desert Rock. This monitor has a low power consumption (12v DC, 0.33 amp, 4.0 Watt) relative to conventional instruments allowing operation with solar-panel charged batteries. Additionally, it does not require a temperature-controlled environment.

The 2B Technologies Model 202 Ozone Monitor™ is designed to enable accurate and precise measurements of ozone ranging from low ppb (precision of ~1 ppbv) up to 100,000 ppb (0-100 ppm) based on the well established technique of absorption of light at 254 nm. "Absorption spectroscopy" is a chemical analysis technique made possible by the phenomenon that a given molecule absorbs light at selected wavelengths. The wavelengths absorbed are characteristic of each molecule's atomic features. The amount of light radiation absorbed by a substance depends on two factors: the number of molecules in the path of the light, and the characteristics of the molecule (e.g., absorption cross-section). Measurement of changes in the light intensity

as it passes through the molecules, and the use of calibration and reference data, enable the determination of the number of molecules encountered.

Accuracy (performance checks)	±5%
Precision (performance checks)	±5%
Resolution	0.001 ppm
Lower Quantifiable Limit	0.002 ppm

EN-SCI Ozone Analyzer (ozonesondes)

The EN-SCI Corporation Model KZ-ECC atmospheric ozone sounding system is designed for ozone measurements from balloon platforms, but for this project was used both from balloon platforms and, in a modified package, for continuous surface sampling at fixed locations (see Section 3.2.1.4). Ozone is measured with an electrochemical concentration cell (ECC) ozonesonde coupled through an electronic interface to a SIPPICAN W-9000 Mark II radiosonde.

The ECC ozonesonde is of a simple design consisting of a rigid mainframe on which is mounted a motor-driven Teflon/glass air sampling pump, a thermistor for measuring pump temperature, an ozone sensing ECC, and an electronics box containing interface circuitry which couple the ozone sensor to the radiosonde. The mainframe is mounted in a lightweight weatherproof polystyrene flight box that is taped and wired to the radiosonde during flight.

The ozone-sensing cell is made of two bright platinum electrodes immersed in potassium iodide (KI) solutions of different concentrations contained in separate cathode and anode chambers. The chambers are linked with an ion bridge that, in addition to providing an ion pathway, retards mixing of the cathode and anode electrolytes thereby preserving their concentrations. The electrolytes also contain potassium bromide (KBr) and a buffer whose concentrations in each half-cell are the same. The driving electromotive force for the cell, of approximately 0.13 V, is provided by the difference in potassium iodide concentrations in the two half cells. Sample air is forced through the ECC sensor by means of a non-reactive pump fabricated from TFE Teflon impregnated with glass fibers. The pump is designed to operate without ozone-destroying lubricants. Pumping efficiency for each pump varies from pump to pump and is also dependent on ambient air pressure. The sampling flow rate is calibrated at the factory and checked in the field before launch. The ECC ozone concentration calibration is also determined prior to launch.

When ozone in air enters the sensor, iodine is formed in the cathode half cell according to the relation

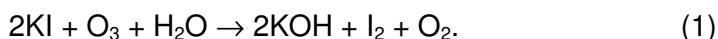

The cell converts the iodine to iodide according to

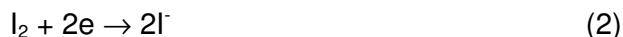

during which time two electrons flow in the cell's external circuit. Measurement of the electron flow (i.e., the cell current), together with the rate at which ozone enters the cell per unit time, enables ozone concentrations in the sampled air to be derived from

$$p_3 = 4.307 \times 10^{-3} (i_m - i_b) T_p t \quad (3)$$

where p_3 is the ozone partial pressure in nanobars, i_m is the measured sensor output current in microamperes, i_b is the sensor background current (i.e., the residual current emanating from the

cell in the absence of ozone in the air) in microamperes, T_p is the pump temperature in kelvins, and t is the time in seconds taken by the sonde gas sampling pump to force 100 ml of air through the sensor.

Sensitivity	2-3 ppb by volume ozone in air
Response Time	15 seconds for 67% of change; 60 seconds for 85% of change
Noise	less than 1% of full scale
Estimated Measurement Uncertainty	less than $\pm 10\%$ of indicated value

Saturation Samplers

The saturation sampler used for CCROPS is based on the potassium iodide (KI) bubbler detection principle described above. As initial design criteria required the sampler to run for at least two to four days between servicing, early designs looked to use the existing ozonesonde type systems for tropospheric and stratospheric soundings with a modified and enlarged cathode cell. The primary reason for enlarging the cathode cell was to provide enough cathode solution to allow evaporation to take place during operation without significantly depleting the amount of the cathode solution. However, while successful in testing, the size and placement of the additional cathode cell, as well as the power requirements needed for continuous operation of the pump over a number of days, suggested an alternative approach. This alternate approach involved using the same cells that are used in the commercial ozonesonde system, and cycling the pump at appropriate intervals to both conserve power and cathode solution. A prototype system was developed in 2003, and tested at the South Coast Air Quality Management District monitoring site in Santa Clarita. This demonstration documented the cycling technique with successful results during a high ozone event. **Figure 3-1** shows the collected data with 5-minute average values at 30-minute intervals, along with the hourly average data from the local ozone monitor.

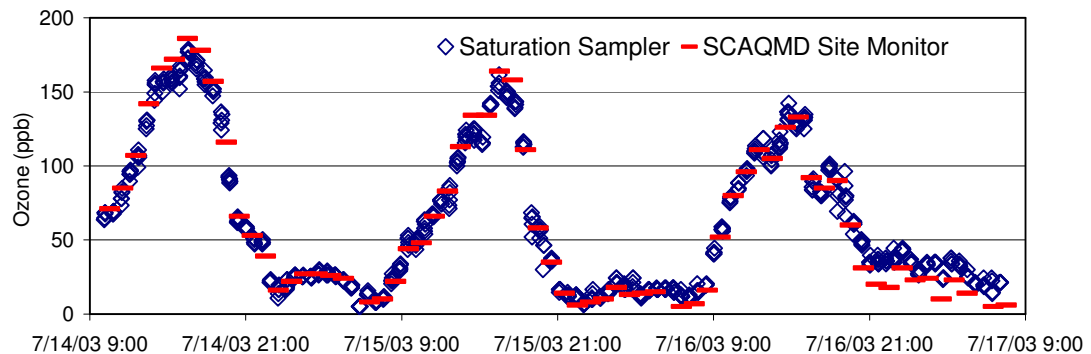

Figure 3-1. Comparison of Saturation Sampler Versus SCAQMD Ozone Data at the Santa Clarita Site in 2003

On the basis of the test results at Santa Clarita, the design was finalized with the system fully self-contained and programmable for continuous running or on and off cycle times. “AA” batteries provided power for the entire system with the ability to operate for up to 5 days without servicing. Data were recorded by a simple multi-channel 8-bit data logger that recorded the cell temperature and current over a nominal range of equivalent ozone concentrations from 0 to 250

ppb, with 1 ppb resolution. This design formed the basis for the samplers built and deployed during the 2005 CCROPS.

During the 2005 ozone season there were four intensive operating periods (IOPs) ranging from one to two weeks in duration during which the saturation sampler operated. Approximately 36 hours prior to the start of an IOP-mode operation, the sample cells and samplers were prepared for deployment. The samplers were then deployed the day prior to the start of the IOP with the original intent of servicing the samplers every three to four days. During the first IOP a more frequent schedule of servicing was used to ensure that the newly designed systems would function properly in the harsh desert environment. It was quickly learned that a service interval of two days was needed to exchange the sample cells as the high ambient temperatures and low humidity evaporated the cathode solutions rapidly. This actually turned out to be advantageous because the data were available sooner for analysis to watch the evolution of the ozone episodes and identify any potential instrument problems.

The design of the samplers allowed a number of deployment options. For some sites, a 3-meter sample line was used to place the sampler at ground level and mount the inlet on an elevated pole. At other sites, the physical sampler was attached to a utility pole. **Figures 3-2** and **3-3** show examples of the sampler mounting. The Styrofoam enclosure was used at each installation and provided both protection for the sampler and insulation for the internal system to regulate, to some degree, the internal temperature.



Figure 3-2. Sampler Mounting at Ground Level with the Sample Inlet at the Top of the Pole



Figure 3-3. Sampler Mounting on a Utility Pole

Accuracy (performance checks)	±10%
Precision (performance checks)	±10%
Resolution	0.001 ppm
Lower Quantifiable Limit	0.002 ppm

Aircraft Measurements

The ozone sampling instrumentation for the aircraft was based on the wet cell KI technique implemented by EN-SCI Corporation for tropospheric and stratospheric ozone profiling, as

described above. The sample pump/cell system was housed in a small case with the output signal from the sampler recorded on a Campbell CR1000 data logger. This data logger allowed the recording and parsing of a serial data stream from a Global Positioning System receiver as well as recording analog signals of pressure, ambient temperature, detection cell temperature and the calculated values of ozone based on the sampled parameters. Data were sampled and recorded at 4-second intervals. A set of AA batteries provided power and the capability for the entire system to measure ozone continuously for over 8 hours. The sample inlet was through a length of FEP Teflon tubing to a region of the respective aircraft in free airflow. For the glider it was through the nose of the aircraft and for the tow plane, it was half way out the wing, on a support strut. The temperature probe in the glider was placed in the fresh air vent, close to the inlet, but away from any region that could cause solar heating. The probe on the tow aircraft was placed near the sample inlet on the wing strut. For each of the sampling platforms, the installation time prior to a flight required approximately 20 to 30 minutes to install, pre-flight and assure that the systems were operational. The system was also used in another of the sailplanes in the soaring association when the primary plane was unavailable. The mounting, GPS and temperature and sample line runs were essentially the same in each of the installations. **Figure 3-4** shows both the primary sailplane and the tow aircraft prepared for launch. **Figure 3-5** shows the basic sampler installed behind the pilot seat in the glider. **Figure 3-6** shows the installation of the package behind the pilot seat in the tow aircraft. The sample line was run out the open window to the mounting on the strut.



Figure 3-4. Sailplane with Tow Aircraft Readied for Launch

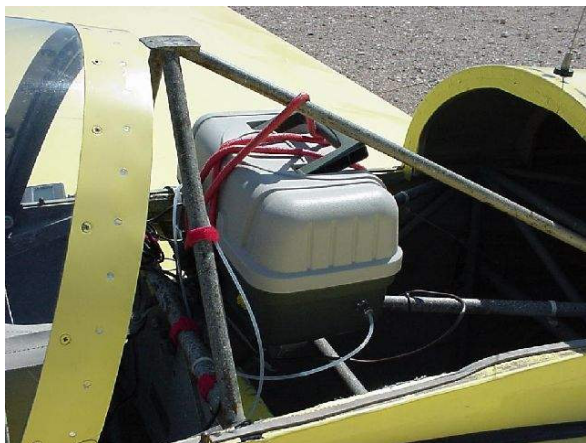

Figure 3-5. Sampler Mounting in Glider with Cowling Removed



Figure 3-6. Sampler Mounting in Back Seat of Tow Aircraft

3.2.2 NO_y / PAN Measurements

Two of the DAQEM network sites were supplemented with analyzers that specifically measured NO_y, nitric acid, NO₂, and peroxyacetyl nitrate (PAN, the most abundant PAcN). The NO_y and NO_y- analyzer was a ThermoEnvironmental model 42CY. The performance of this analyzer has been described previously². **Figure 3-7** is a schematic drawing of how the analyzer was configured. The external converter housing was a stainless steel box with fiberglass insulation. The box was, therefore, slightly warmer than ambient air due to the heat released by the two converters. A minimum amount of ¼ inch outside diameter PFA tubing (15 cm) was used to direct the ambient air into the converters. A sodium chloride fabric denuder³ was used to selectively remove nitric acid from one channel. Nitric acid is therefore measure by subtracting the concentration from the channel scrubbed of nitric acid from the NO_y concentrations. Each channel was sampled twice per minute for ten seconds. Multi-point calibrations were performed at the beginning and end of the study period using a commercial calibrator to dilute NO in nitrogen from a certified compressed gas cylinder. The gas phase titration of NO with O₃ by the calibrator was used to verify converter efficiency. Daily span and converter checks were automatically performed with the calibrator.

NO₂ and PAN were measured using a gas chromatograph with luminol detection. **Figure 3-8** shows a schematic diagram of the NO₂/PAN gas chromatograph. Sample is drawn through a 1 ml PFA Teflon[®] sample loop connected to a six-port GC injection valve (Valco Instruments model 000-0106L). The sample is injected at 2-minute intervals (i.e. the sample switched briefly into the carrier stream) into a chromatographic column (J&W Scientific DB1, 0.53 mm bore, 3 µm coating) maintained at room temperature. Dry, purified air is used as a carrier gas. PAN elutes from the column several seconds after NO₂. In the detector, a luminol solution on a wick reacts with NO₂ and with PAN, generating light that is detected by a photomultiplier tube (Hamamatsu Corporation model H5920-01). A buffered solution containing luminol⁶ (0.05M NaOH, 0.1 M Na₂SO₃, 2x10⁻⁴ M luminol and 0.05% (v/v) *tert*-butyl alcohol in deionized water) is supplied to the wick with a piston pump (Fluid Metering Inc. model QG6), and used luminol solution exits the detector with the carrier gas. The intensity of the light is proportional to the amount of NO₂ or PAN reactant present in the detector. The output of the PMT is amplified and directed to the NO₂/PAN GC computer data acquisition and control system, which stores and analyzes one complete chromatogram every two minutes. The software used is based on Labview[®]. The total area of the NO₂ and PAN peaks in the chromatogram are calculated as well as the area within an equivalent time of baseline. Calibration factors are applied to the net area, and the resulting ambient NO₂ and PAN concentrations in ppb are stored on the NO₂/PAN GC computer along with the original chromatogram. Carrier gas flows were adjusted to clearly separate the NO₂ and PAN and allow the tail of the PAN peak to return to baseline before the background was determined. Carrier flow rates of 20-40 ml were generally found to be optimum. The response to NO₂ and PAN was found to be similar on a molar basis and NO₂ generated from calibrator from gas phase titration of NO with O₃ was used to calibrate the response. Daily zero span checks were performed automatically and simultaneously with the NO_y-NO_y- analyzer.

Accuracy	
NO _y , NO _y ⁻ , and Nitric Acid	±15%
NO ₂ and PAN	±15%
Precision	
NO _y , NO _y ⁻ , and Nitric Acid	±10%
NO ₂ and PAN	±10%
Output Resolution	
NO _y , NO _y ⁻ , and Nitric Acid	0.5 ppb
NO ₂ and PAN	1 ppb
Lower Quantifiable Limit	
NO _y , NO _y ⁻ , and Nitric Acid	1 ppb
NO ₂ and PAN	2 ppb

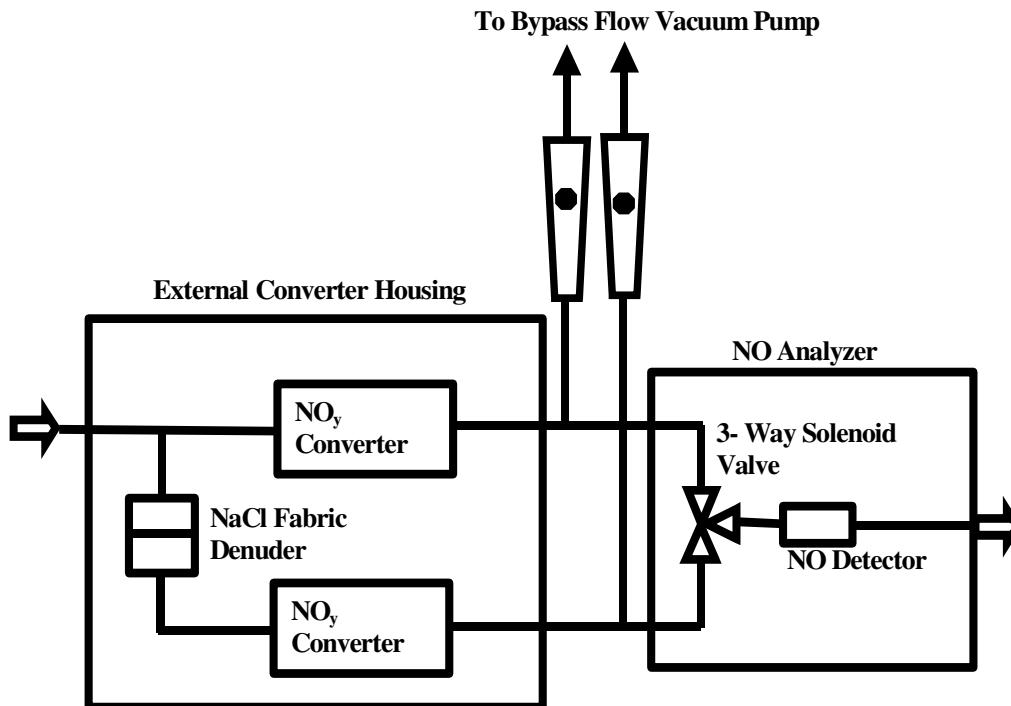

Figure 3-7. Schematic Diagram of NO_y Analyzer Configuration

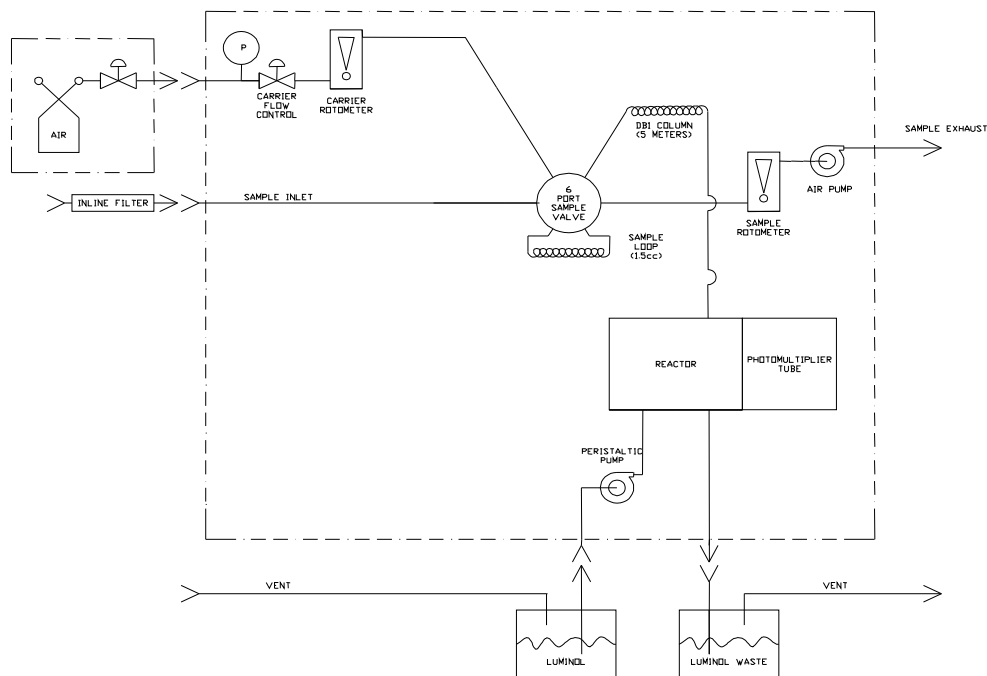

Figure 3-8. Schematic Diagram of NO₂/PAN Gas Chromatograph

3.2.3 VOC Measurements

The DRI Canister Sampler takes air from the sample inlet and injects it into a canister or bag at a constant flow rate for a preset time. The excess air is released through the bypass exhaust. The constant flow rate and elapsed time allow the operator to compute the volume of the integrated air sample. The sample is pumped through a 12 V.D.C. pump which develops sufficient pressure to control the flow with a Variflo regulator. The pump also samples the air at a flow rate sufficient to keep any long sampling lines flushed. A small, constant flow of sampled air is pumped into the sample container. The sampler is automatically purged for five minutes at the beginning of each run. The timer turns on the pump for five minutes before the canister solenoid is turned on. Following sampling, the solenoid is shut off to seal the canister until an operator can shut off the canister valve. The canister is also be sealed with a Swagelok cap.

To analyze the sample, a known volume of gaseous sample is passed through a cryogenically cooled trap, cooled with liquid nitrogen, cryogenically trapping out C₂ and heavier VOCs without trapping methane, oxygen, or nitrogen. The trap containing the condensed VOC is heated to ~80°C and its contents injected into a gas chromatographic (GC) capillary column where separation of the VOCs takes place. Detection of the hydrocarbons is by mass spectrometry, and the resultant peaks are quantified and recorded on a computer system. Some hydrocarbons have such low molecular weight that they are impractical or impossible to analyze by mass spectrometry and these are separated on line and detected.

Accuracy (performance checks)	±10%
Precision (performance checks)	±10%
Background Carryover	<10 ppbC
Lower Quantifiable Limit	0.01-0.05 ppbC

4. FIELD PROGRAM

4.1 Basic Elements

The following three-tiered field monitoring effort was developed to maximize the effectiveness of study resources.

- Supplemental air quality and meteorological monitoring, including ten surface ozone and meteorological monitoring sites, two NO_y monitoring sites, and four upper-air monitoring sodars and a radar wind profiler. This monitoring occurred continuously from May 15 through August 31, 2005.
- IOP monitoring, consisting of continuous saturation ozone measurements at up to 13 locations and rawinsonde measurements at one location. These measurements were conducted during six “windows of opportunity” when conditions for ozone concentrations were predicted to be good for an extended period of time.
- Episode-mode monitoring, consisting of ozonesondes at one location, VOC sampling at three locations, and some additional balloon meteorological measurements at various locations. These were two to three day periods that were imbedded within the IOP monitoring effort, when ozone concentrations were predicted to be near or above the Federal 8-hr standard of 85 ppb.

Table 4-1 summarizes the three-tier and the CCROPS measurements.

Table 4-1. CCROPS Measurements

Period of Operation	Measureables
Entire study period (May 15 – August 31)	<ul style="list-style-type: none"> • Continuous ozone and meteorology at 10 additional sites • Continuous upper-air meteorology at 4 sites (4 SODAR, 1 radar profiler) • Continuous NO_y, PAN, Nitric Acid measurements at 2 sites
Intensive Operational Periods (four 1- to 2-week periods of potential high ozone conditions)	<ul style="list-style-type: none"> • Upper-air meteorology using rawinsondes at 1 site • Continuous ozone using portable samplers at up to 13 saturation sites
Episode-Mode Operations (1- to 3-day periods of forecasted high ozone imbedded within IOPs.	<ul style="list-style-type: none"> • VOC samples at 3 sites (up to 4 samples per day) • Upper-air ozone measurements using ozonesondes at 1 site (6 AM, 10 AM, 4 PM) • Upper-air ozone measurements using aircraft/glider (typically 6 AM and 10 AM) • Pibal and rawinsonde measurements at various sites throughout western Clark County

4.2 Operations Summary

The field-monitoring phase of the program was conducted during May through August 2005. The complete surface monitoring network and balloon-borne upper air measurements were completely functional by May 15. The sodars and radar wind profiler were phased in as the equipment was installed and became operational. The effective ozone season in Clark County is May through August. Historically the first ozone episode has not occurred before May 15 (the only exception in the prior 9-year record is May 9, 2004). The 2005 ozone season was no exception. The first exceedance of the 8-hr ozone standard occurred on June 12.

The IOP and episode-mode levels of monitoring efforts were distributed throughout the ozone season as originally intended. The plan was to include a representative set of meteorological conditions during which high ozone levels are experienced in Clark County. For planning purposes, it was supposed that IOP periods would occur over three 2-week periods occurring near the start, in the middle, and towards the end of the ozone season. Episode-mode field activity was thereby based on high ozone levels being forecast while the IOPs were ongoing, and the field crews were already deployed in the field. As it turned out, IOPs operations occurred on 38 days over the following 6 periods. The late August IOPs were an attempt to capture a solid “interbasin transport” high ozone case.

- May 15-16 (intended as a “shakedown period” as well)
- May 23-29
- June 20-July 2
- July 11- 21 July
- August 21-22
- August 27-29

Embedded in these IOPs were a total of 15 episode-mode days. Nine of these days occurred during June and July, consistent with historical observations indicating that peak ozone activity in Clark County occurred during June and July.

A complete summary of daily activities from May 15 through August 31 are given in **Table 4-2**. A lot of information is contained in this table. In addition to the project operational status, the peak 8-hr ozone levels from Jean and Joe Neal sites and number of exceedances are noted, if any, as well as the number and types of special measurements made. Jean and Joe Neal ozone levels are generally indicative of background (upwind) levels and peak levels in the Las Vegas Valley, respectively.

IOPs consisted of deploying a network of *saturation* ozone monitors and twice-daily rawinsonde measurements from the North Las Vegas airport. Rawinsondes were taken near sunrise (~ 06 PDT) to measure the lower atmosphere during the most stable period of the diurnal cycle, and in the afternoon (~ 16 PDT) to measure the lower atmosphere when the boundary layer is the most unstable and vertical mixing has peaked.

Variations in operations occurred with the balloon-borne ozonesonde/rawinsondes depending on how forecasted ozone levels evolved during the day. On some “episode-mode” days, the full complement of ozonesondes was not made if high ozone levels did not materialize as forecast. On other days, the field crew made ozonesonde measurements when none were scheduled but

ozone levels were greater than forecast. The operations were kept dynamic in an attempt to monitor the real-time conditions and respond accordingly.

A weather forecasting protocol was developed for the CCROPS that combined the data information resources and expertise of both the DAQEM and the CCROPS operators in order to issue daily, specialized weather updates and advisories. These forecasts provided project management with the information required to call for the IOP and episode-mode monitoring efforts. The forecast discussion and specific forecasts were posted daily to the project web site. The general meteorological conditions encountered during the field study are described in the following section.

4.3 Meteorological Conditions

A synopsis of the general meteorological conditions affecting ozone development during the 2005 CCROPS field monitoring study can be accomplished by examining the daily synoptic scale weather characteristics over the Southwestern U.S. during the project period (May 15 to August 31). It was determined during the Ozone Characterization Study¹ that the 500 mb constant pressure patterns provide the most representative prospective of the synoptic influence on regional dispersion characteristics. Daily 500 mb charts were examined for three ozone seasons resulting in the identification of a number of patterns and parameter values that appeared to correspond to ozone or non-ozone days in southern Nevada. The same process was carried out for the 2005 project period, resulting in the following summary.

May 15 - 19

The synoptic pattern during the 15th featured a short-wave high pressure ridge that drifted across the study area bringing warmer stable conditions and light flow. By the 16th, a short-wave trough was approaching the area from the west coast. This feature turned flow to the southwest, but also brought in cooler air and better mixing conditions to southern Nevada. The pattern of short-wave ridges and troughs continued through May 19th, resulting in a fairly unsettled dispersion scenario that did not allow much build up of pollutants.

May 20 – 29

The main synoptic feature that dominated the regional pattern during this period was a strong high pressure ridge that remained located over the Southwest U.S. for more than a week. Initially, a weak short-wave trough passed over the top of the ridge in the northern Great Basin, but the strong ridge kept this type of feature from affecting the warming and stabilizing conditions in the study area. The ridge produced near record high temperatures around the 22nd and 23rd, and also relatively poor dispersion conditions. Wind flow generally was light during most of the period, with intra-basin flow apparently predominating. By the 28th, the ridge weakened considerably as low pressure to the north and south eroded its strength. At the same time, a subtropical low in the southern Baja became a more dominant synoptic feature as it started injecting moisture and less stability into the Southwest. Late on the 28th, a short-wave trough to the north started influencing the wind flow in southern Nevada as it approached the great Basin from the West Coast. The trough also transported the additional moisture from the Baja low into the study area causing a broken cloud cover after dark. Wind flow late on the 28th and early on the 29th increased considerably from the southwest, enhancing inter-basin transport during the overnight hours. The cloud cover did prevent nocturnal radiation cooling and helped maintain a neutral stability condition overnight, thus allowing pollutants aloft to mix to the surface. During the daylight hours on the 29th, the strong southwesterly flow continued,

but the cloud cover dissipated, and good thermodynamic and turbulent mixing predominated during the remainder of the day.

May 30 – June 11

The short-wave frontal passage that occurred during the day on the 29th was followed by a short-wave ridge on the 30th. Brisk wind flow and good mixing continued in the study area during both days. By June 1st, a general long-wave troughing pattern became the dominant synoptic weather feature for the next ten days. During that time, temperatures were somewhat cooler than average and mixing was generally good. A short ridge embedded in the general pattern migrated through the area around June 4th and 5th, temporarily increasing temperatures aloft and decreasing dispersion efficiency.

June 12 – 16

A nicely defined ridge moved into the Great Basin from the West Coast on the 12th, quickly displacing the long-wave trough that had been so dominant since the beginning of the month. The ridge, however, was migratory, and drifted off to the east by the 16th. Wind flow tended to be light during the 12th to the 15th, apparently favoring intra-basin transport during that time. A developing West Coast trough turned flow in the study area around to the southwest by the 15th, thus indicating a greater opportunity for inter-basin flow.

June 17 – 21

West Coast troughing developed into a strong closed low just off the Oregon Coast during this period. Significant on-shore flow predominated throughout the Southwest as a result. Although the southwesterly wind flow was indicated strong inter-basin transport potential, the air mass was cooler and well mixed because of the cyclonic synoptic pattern.

June 22 – 25

The strong West Coast low had weakened and broadened into a trough off the coast by the 22nd. At the same time, a very larger high pressure ridge centered in the western Plains expanded to the west. The interface zone between the influence of the trough and ridge was generally situated over the Great Basin during this period. As a result, regional flow remained southwesterly while the air mass stabilized somewhat due to the ridging influence to the east. Unfortunately, the interface zone also contained a stronger pressure gradient, which manifested itself with breezy afternoon local winds and also some local cumulus development over higher terrain. Flow during the period was mostly inter-basin.

June 26 – 28

The West Coast low/trough finally progressed from west to east as a shortwave trough during this period. As this system moved across the Great Basin, it kicked off considerable thunderstorm activity, particularly in Utah and northern Arizona. The storms were based, and therefore many areas experienced “dry” lightning strikes, including around the study area. An outbreak of wildfires in southern Nevada, Arizona and Utah resulted.

June 29 – July 3

A flat high pressure ridge built into the southern Great Basin by the 29th as the short-wave trough exited to the east. The ridge brought an end to the thunderstorm activity with increased air mass stability and a lack of moisture. The stable air mass brought capping subsidence layers to the study area and very light flow below the cap. Boundary layer flow (below ~12,000 ft) in the study area was initially from the east on the 29th, and then became light intra-basin by the 30th. The flat ridging scenario continued through July 1st with stagnant conditions prevailing in the southern Great Basin. By July 2nd, a weak west to east zonal flow pattern developed in the boundary layer, which was reflective of the conditions higher aloft during the period. A series of weak short-wave troughs also migrated across the northern Great basin within the zonal flow pattern. During the 2nd and 3rd, boundary layer flow became light southwesterly as a result of the synoptic pattern. The zonal flow pattern was not strong enough to destabilize the air mass and the capping subsidence layer persisted over the boundary layer. This scenario resulted in the best inter-basin transport conditions of the summer.

July 4 – 8

Weak zonal flow associated with a persistent flat ridge over the extreme southern Great Basin and northern Mexico continued through July 8th. Several migrating short-wave troughs moved across the Great Basin north of the study area. Air mass stability remained fairly consistent, varying slightly from day to day depending on the location of the current short-wave troughs. Wind flow also remained light during the period, with trajectories favoring inter-basin transport from the west to the east during several periods, depending on the short-wave locations. The overall synoptic pattern was rather flat and poorly defined over the southern half of the western U.S., which is rather typical for mid summer.

July 9 – 11

A West Coast trough located initially off Washington and Oregon dug its way southeastward during this period. The trough was actually induced by a Pacific high pressure area to its west that was slowly building during previous days. The trough brought increased on-shore flow to the west, extending well into the Great Basin by the 10th. The result was a break up of the stable air mass over the study area and an increase in thermodynamic and turbulent mixing.

July 12 – 21

This entire period can be characterized by a persistent strong long wave high pressure ridge that remained centered over the interior west for more than ten days. This large synoptic feature spread in from the Pacific to combine with the flat ridging that had been over northern Mexico and the southern plain for many days previously. The center of the ridge wobbled around the southern Great Basin, sometimes west of the study area, but more often to the east in the general vicinity of the Four Corners area. The ridge was responsible for producing an extended period of record high temperatures in the Las Vegas area, and throughout the Southwest U.S. The air mass associated with the ridge was stable and rather stagnant, featuring light flow and high-level subsidence capping. The intense surface heating during the afternoons likely increased the depth of the boundary layer in the study area and induced local flow regimes. Synoptic scale flow during the period was quite light and mostly from east to west during the period. There was very little indication of large-scale inter-basin transport, at least not from west to east.

By late on July 20th, the center of the ridge had shifted to east of the Four Corners area, and flow in the study area shifted to the south to southeast. The shift opened the door for possible inter-basin transport from the south along the Colorado Valley. The flow trajectory also started a monsoonal fetch in that brought mid-level cloudiness to the study area. Besides inhibiting new ozone production, the clouds also began to change the thermodynamic configuration of the air mass.

July 22 – August 3

A large long-wave high pressure ridge remained centered east of the Four Corners area, often all the way back to the southern Plains during this entire period. The resulting south to southeast fetch around the western flank of the ridge brought day after day of monsoonal flow to the southern Great Basin. The flow tapped into a rich moisture source in northern and central Mexico that was constantly replenished by a series of tropical disturbances migrating in the subtropical easterlies. There was no flow in the study area with a westerly component, thus precluding inter-basin transport from the west, and early day local ozone development was broken by convective thunderstorm activity (sometimes severe) in the afternoons.

August 4 – 13

The long protracted monsoonal activity that was established by July 22nd continued during this period as well. However, several short breaks occurred in the cycle that enabled localized ozone development in the study area. These occurred on the 6th and 10th. A short-wave trough moved through the northern Great Basin on the 4th, leading in a fresh short-wave ridge from the west. When the axis of the ridge approached the study area, it temporarily cut off the monsoonal fetch and as a result, ozone development was curtailed by afternoon thunderstorms on the 6th. However, there was no inter-basin flow from the west during this day.

No thunderstorm activity took place in the study area on August 10th. The monsoonal moisture was temporarily cut off that day by the influx of drier air from California. The dry line quickly slipped back to the west of the area by the 11th. Flow in the drier air mass was more southerly with a possible westerly component, but the event was too short-lived to allow the establishment of consistent inter-basin transport from the west.

August 14 – 26

Afternoon monsoonal thunderstorm activity was continuing in southern Nevada by August 14th. However, troughing off the southern California coast, and also off southern Baja, was beginning to combine with the monsoon pattern. During subsequent days, the West Coast troughing developed into a rather vigorous closed low off Point Conception California. Rotation around the low brought cooler air into the study area, but the unstable nature of the air mass triggered more thunderstorm activity in the southern Great Basin. Good mixing and variable cloudiness curtailed pollution development in the study area. Another low off the California Coast around the 18th produced much less cloudiness, but the well-mixed nature of the air mass kept the boundary layer clean of pollutants. During most of this period, flow trajectories had turned far enough from the southeasterly monsoonal direction to set up inter-basin transport flow. However, the well-ventilated composition of the air mass precluded the formation of any pollutants to transport.

August 27 –31

The influence of the West Coast troughing in the study area was curtailed during the final five days of the project by a ridge of high pressure building into the region from the southern Plains. Circulation around the ridge did not bring a monsoonal fetch with, as was the case for so many days earlier during the project. Instead, the southerly flow generated by the ridging to the east and troughing to west resulted in inter-basin type flow with a westerly component. The influx of the ridge was enough to stabilize air mass, but pollution levels up wind in California never materialized enough to provide a significant source. The closer proximity of the trough and the lateness of the season probably were probably responsible for the poor development in California.

Table 4-2. Network Operational Status and Daily Summaries

Date	TOP	Episode	Max Jean 8-hr Ozone (ppb)	Max Joe Neal 8-hr Ozone (ppb)	Supplemental Sites Operational	Saturation Sites Operational	Rawinsondes Operational	Ozonesondes Launched	Piballs Launched	SODARS Operational	Radar Profilers Operational	VOC Samples Operational	NOy Sites Collected	Glider/Tow Aircraft Flights	Ozone Exceedance Day	Comments
15-May	X		73	68	9	9	0			0	0	0	2			
16-May	X		54	55	9	9	2			0	0	0	2			
17-May			60	60	9					0	0		2			
18-May			49	54	9					0	0		2			
19-May			47	49	9					0	0		2			
20-May			46	40	9					0	0		2			
21-May			67	71	9					0	0		2			
22-May			72	76	9					0	0		2			
23-May	X		56	61	9	9	2			1	0		2			
24-May	X	X	62	59	10	11	3	3		1	0	6	2			
25-May	X		82	74	10	10	2			1	0		2			
26-May	X		71	75	10	10	2			1	0		2			
27-May	X	X	70	75	9	12	3	3		1	0	6	2			
28-May	X	X	77	69	9	11	3	3		1	0	6	2			
29-May	X		73	68	9	11	2			2	0		2			
30-May			63	61	9					3	0		2			
31-May			64	76	10					3	0		2			
1-Jun			81	70	10					2-3	?		2			
2-Jun			76	71	10					2-3	?		2			
3-Jun			71	61	10					2-3	?		2			
4-Jun			74	71	10					2-3	?		2			
5-Jun			77	76	10					2-3	?		2			
6-Jun			70	67	10					2-3	?		2			
7-Jun			64	62	10					2-3	?		2			
8-Jun			65	67	9					2-3	?		2			
9-Jun			44	35	9					2-3	?		2			
10-Jun			52	59	9					2-3	?		2			
11-Jun			66	61	9					2-3	?		2			
12-Jun			79	42	9					2-3	?		2	3		"Surprise Sunday"
13-Jun			72	67	9					2-3	?		2			
14-Jun			66	66	9					2-3	?		2			
15-Jun			72	67	9					2-3	1		2			
16-Jun			79	70	10					2-3	1		2			
17-Jun			62	61	10					2-3	1		2			
18-Jun			66	58	10					2-3	1		2			
19-Jun			57	59	10					2-3	1		2			
20-Jun	X		58	58	10	12	2			2-3	1		2			
21-Jun	X		56	61	10	12	2			2-3	1		2			
22-Jun	X	X	62	54	10	12	6	3	8	2-3	1	13	2			
23-Jun	X	X	66	68	9	12	6	3	8	2-3	1	13	2	2		
24-Jun	X	X	69	66	9	13	6	2	8	2-3	1	13	2	1		
25-Jun	X		66	60	9	13	2			2-3	1		2			
26-Jun	X		75	76	9	12	2			2-3	1		2			
27-Jun	X		65	57	9	13	2			2-3	1		2			
28-Jun	X		69	67	9	13	2			2-3	1		2			
29-Jun	X		88	99	9	12	2	1		2-3	1		2		12	Fires
30-Jun	X		92	105	9	12	2			2-3	1		2		12	Fires

Table 4-2. Network Operational Status and Daily Summaries (Continued)

Date	IOP	Episode	Max Jean 8-hr Ozone (ppb)	Max Joe Neal 8-hr Ozone (ppb)	Supplemental Sites Operational	Saturation Sites Operational	Rawinsondes Operational	Ozonesondes Launched	Piballs Launched	SODARS Launched	Radar Profilers Operational	VOC Samples Operational	NOy Sites Collected	Glider/Tow Aircraft Flights	Ozone Exceedance Day	Comments
1-Jul	X	X	81	79	9	13	6	3	8	2-3	1	13	2	2		
2-Jul	X	X	85	81	9	13	6	3	8	2-3	1	13	2	4	1	
3-Jul			76	87	9					2-3	1		2		1	Ended IOP due to non-typical holiday
4-Jul			70	75	9					2-3	1		2			
5-Jul			73	76	9					?	?		2			
6-Jul			81	77	9					?	?		2			
7-Jul			77	78	9					?	?		2			
8-Jul			83	86	9					?	?		2		1	Paute also showed exceedance
9-Jul			65	67	9					?	?		2			
10-Jul			56	63	9					?	?		2			
11-Jul	X		53	64	9	11-13	2			?	?		2			
12-Jul	X		57	69	9	11-13	2			?	?		2			
13-Jul	X		56	74	9	11-13	2			3	1		2			
14-Jul	X	X	70	84	9	11-13	6	3	7	3	1	X	2	1		Near exceedance at County site
15-Jul	X	X	67	85	10	11-13	6	3	8	3	1	X	2	1	3	
16-Jul	X		72	81	10	11-13	2			3	1		2			
17-Jul	X	X	70	68	10	11-13	6	3	8	4	1	X	2	1		Sunday event sampling
18-Jul	X		72	91	10	11-13	5		9	4	1		2		5	Local "sloshing"
19-Jul	X		70	74	10	11-13	5		8	4	1		2			
20-Jul	X	X	68	76	10	11-13	6	4	8	4	1	X	2	1		Transport, but cloudy
21-Jul	X		62	70	10	11-13	5			4	1		2			
22-Jul			57	68	10								2			
23-Jul			50	62	10								2			
24-Jul			46	61	10								2			
25-Jul			62	74	10								2			
26-Jul			67	74	10								2			
27-Jul			62	72	10								2			
28-Jul			53	59	10								2			
29-Jul			53	65	10								2			
30-Jul			62	78	10								2			
31-Jul			58	71	10								2			
1-Aug			57	71	10								2			
2-Aug			59	63	10								2			
3-Aug			50	71	10								2			
4-Aug			69	72	10								2			
5-Aug			64	NA	10								2			
6-Aug			67	NA	10								2			
7-Aug			66	NA	10								2			
8-Aug			72	65	10								2			
9-Aug			51	48	10								2			
10-Aug			64	79	10								2			
11-Aug			62	73	10								2			
12-Aug			82	84	10								2			Near exceedance, but no transport
13-Aug			67	73	10								2			
14-Aug			43	53	10								2			
15-Aug			52	53	10								2			
16-Aug			47	53	10								2			
17-Aug			42	49	10								2			
18-Aug			49	49	10								2			
19-Aug			49	54	10								2			
20-Aug			47	59	10								2			
21-Aug	X		52	62	10	11-12	2			4	1		2			
22-Aug	X	X	52	56	10	11-12	7	2	8	4	1	X	2	2		
23-Aug			60	62	10								2			
24-Aug			50	54	10								2			
25-Aug			42	45	10								2			
26-Aug			39	44	10								2			
27-Aug	X	X	51	66	10	NA	1	1		4	1	X	2	2		
28-Aug	X	X	58	72	10	NA	1	2		4	1	X	2	2		
29-Aug	X		58	54	10	NA	1	2		4	1	X	2	2		Transport flow, but good mixing
30-Aug			62	48	10								2			
31-Aug			56	56	10								2			

5. QUALITY ASSURANCE AND DATA VALIDATION

Quality assurance (QA) for CCROPS was achieved through a number of specific efforts, which are summarized below.

5.1 Project Plan

The CCROPS project plan was created in the form of a frequently updated, project-specific web site accessible through the Internet. The web site contained the following web pages:

- Study Overview - This page presented a brief overview of the study, the study objectives, and study schedule.
- What's New? – This page served as “document control” for the web site, providing a complete history of all modifications to the web site. Anytime the web pages were expanded or modified, a brief summary and the date of the modification were posted.
- Project Status – This page provided information regarding the readiness of participants' monitoring efforts. The page was particularly important during the early stages of the study period for helping to maintain the study schedule.
- Study Forecast – This page provided for the communication of study-specific information regarding forecasted ozone conditions, and served as the alert for IOPs and episode-mode monitoring efforts.
- Monitoring Sites – This page provided a description of the CCROPS measurements and a map of the measurement locations.
- Project Participants – This page provided a list of the CCROPS participants, a summary of each participant's study responsibilities, and contact information for key individuals.
- Planning Documents – This page requested and posted measurement quality assurance documentation. This is discussed in more detail below.
- Preliminary Analysis – This page provided participants with a means to present preliminary analysis of collected data. This in turn provided study management with feedback regarding collected data versus study goals, and the means of refining the monitoring effort, if needed.

5.2 Quality Assurance/Quality Control Documentation

The following two sets of tables were initially requested from participants regarding the Quality Assurance program implemented by each for the measurements that they conducted:

- Measurement Quality Objectives (MQOs): MQOs were requested for each of the study measurements. In defining these objectives, participants were in essence describing their quality assurance program. One table was filled out for each parameter that the participant was measuring. Examples and a recommended format were provided in order to provide consistency in submitted information.
- Standard Operating Procedures (SOPs): A list of SOPs used by each of the participants was also requested. This list demonstrate that procedures had been developed and documented for each of the measurement activities, and provided those interested with

a mechanism for obtaining more information regarding quality assurance and quality control procedures in place for each of the measurements.

At the end of the study, a standardized metafile format was developed for submission of collected data. Information from MQOs and SOPs were combined and included in the metafiles. The metafiles contained additional descriptions of QA/QC activities, as well as pictures of all of the monitoring locations. Metafiles for all of the CCROPS measurements are contained in Appendix A.

5.3 Data Validation

All data collected for CCROPS were validated to Level 1 validation (see section 6). As part of the validation effort, participants were requested to evaluate whether data collected met the stated MQOs. If data clearly did not meet MQOs, they were removed from the database as invalid data. If, however, data missed meeting the primary MQOs in a definable way to the point where the data were still considered useful, participants had the ability of assigning secondary MQOs to the data in question. This use of secondary MQOs had to be specifically documented in the metafiles.

In reviewing the validity of the data submitted for CCROPS, it should be noted that the data submitted by DRI for the Desert Rock and Mountain Pass sites are of a different validity than that for the rest of the CCROPS network. Measurements at these sites were not initially planned, but were provided by DRI as an additional, though non-funded, effort. With no funding, QA for these sites was not provided, and calibrations conducted at each site by T&B personnel revealed significant issues, both in siting and operations. Initial attempts to use the data in analysis were problematic. Before use, data from these sites should be closely evaluated.

An effort that is yet to be completed is a quality control review of the sodar and radar wind profiler data. This review is being performed by DRI and will include comparisons of rawinsonde and pibal information to the data collected at each of the remote sensing upper-air sites. The results of this comparison are not available as of the date of this report.

6. DATABASE DESIGN

A primary study objective was to produce an adequately validated data set from the field measurements that is well defined and documented within the desired completion time. The overall goal of the data management effort was to create a system that is straightforward and easy for users to obtain data and provide updates.

Each organization was responsible for reviewing and validating their collected data. The raw data was validated to level 1 as described in “The Measurement Process: Precision, Accuracy, and Validity”² before being submitted to the database. This included flagging values for instrument downtime and performance tests, applying any adjustments for calibration deviation, investigating extreme values and applying appropriate flags. Flags used for CCROPS are presented in **Table 6-1**. Each contractor was responsible for documenting the validation process so that it could be provided to the data manager and other analysts if needed.

In addition, each data provider was responsible for furnishing information regarding the monitoring equipment used in the field study and any additional site information to the data manager as requested to enhance the overall documentation of the study. In particular, participants provided the Monitoring Quality Objective (MQOs) define the quality of all data submitted as “valid.” These MQOs contain the following:

- Accuracy
- Precision
- Lower quantifiable limit
- Resolution
- Completeness

If cases exist where data did not meet the primary MQOs but is still deemed useable and can be defined with a secondary set of MQOs, these additional MQOs and the dates to which they apply were also submitted.

Table 6-1. Data Flags

Flag	Description
V	Valid. Data meets primary MQOs.
S	Valid, but does not meet primary MQOs. Secondary MQOs in effect.
I	Data invalid.
M	Missing. Measurement not taken.

Once the data were validated to level 1, the data were prepared for submittal to the database in a form that clearly defined the time reference, averaging period, parameter names and units. The time reference for the database is local standard time (Pacific Standard Time) and the averaging period reference was standardized to hour beginning (0 – 23). The data were submitted as ASCII comma delimited text files or excel spreadsheet files, with data columns well defined to clarify site identification, parameters, instrumentation, units, and time reference.

Participant's also submitted a metadata file for each measurable. This metadata file includes all pertinent information regarding the measurement process, including the information described in Section 3. This metadata file was received prior to inclusion of the data in question into the final dataset.

Data were submitted in a format similar to that of the final database structure, as outlined below. This basically has a second column for each measured value for an accompanying QC code. Data flagged as invalid or missing was given a value of -9999. In the event that data for a given measurable is either valid (meeting primary MQOs) or missing, participants need not supply the flag column, this was specifically stated in the metafile.

Preliminary Database Management Design

T&B Systems assimilated the submitted data into an integrated relational Microsoft ACCESS database and is managing the data for subsequent distribution and analysis. The database consists of both information and data files. The goal was to make the database very usable by data analysts and all participants.

The following describes the preliminary design for the database. The database includes an inventory spreadsheet file to help users track and ensure all of the data was submitted and processed in a timely and consistent manner. All data files submitted were examined to verify unique names for all sites, instruments, and parameters so that no orphan or duplicate records exist in any of the tables. A system was also designed for identifying the version and or modification date of all data files.

The main metadata file is a site file that contains all site information as specified above. Data were organized and grouped together by platform, averaging period and data type.

Surface hourly meteorological data have the following flat format:

Surface Hourly Meteorological Data

SITE, DATE, HOUR, WS, WS_QC, WD, WD_QC, TP, TP_QC, and any additional met parameters and QC codes, if collected.

There are three file types for surface air quality with the following formats:

Ozone 8-hr Averaged:

SITE, DATE, HOUR, O3_8HR, O38HR_QC

Hourly Surface Air Quality:

SITE, DATE, HOUR, OZONE, O3_QC, NO, NO_QC, NOx, NOx_QC, NOy, NOy_QC, PAN, PAN_QC and any additional air quality parameters if collected and QC codes.

NMHC VOC:

SITE, DATE, HOUR, START_TIME, END_TIME, CANNISTER_ID, QC_CODE, PARAMETER1, PARAMETER2, PARAMETER3,..PARAMETERn, notes

Upper-Level Meteorological and Air Quality Data

The rawinsonde, ozonesonde, pibal, and glider data measured during episode-mode operations are stored together in a file with the following format:

**SITE, DATE, TIME, HEIGHT, PRESSURE, PRESSURE_QC,
O3, O3_QC, WS, WS_QC, WD, WD_QC, TP, TP_QC, RH, RH_QC**

The data are formatted into the final database with the following unit configurations and naming conventions:

Parts per million for O₃, NO_x, NO_y

Meters per second for wind speed (as a general rule, metric units will be used)

Degrees Celsius for ambient temperature

Percent for relative humidity

Parts per Billion Carbon for non-methanated hydrocarbon species

SITE = Alpha-numeric site code identifier

DATE = (MM/DD/YY)

HOUR= Nearest whole begin hour (HH) (PST)

TIME, START_TIME or END_TIME = Time stamp of data (HH:MM:SS) (PST)

HEIGHT = Elevation in meters above MSL

QC_CODE (for NMHC-VOC), WS_QC, WD_QC, O3_QC, etc =

“V” (valid), “M” (missing), “I” (invalid), “S” (secondary MQOs)

NOTES = any additional information

The level 1 data files along with the documentation files are available for download on an FTP server.

7. SUMMARY OF THE OBSERVATIONS (DESCRIPTIVE ANALYSIS)

The Ozone Characterization Study (Lehrman et al, 2005) pointed out major gaps in our knowledge of the relationships between air quality and both regional and local meteorological features. The 2005 field study was designed to address a number of these shortcomings. In this section, preliminary analyses of the field measurements are provided which speak to the following questions:

- How well does the existing DAQEM monitoring network measure the maximum ozone exposure in Clark County?
- How well does the existing DAQEM monitoring station at Jean represent ozone background levels in Southern Nevada and the Las Vegas Valley?
- What are ozone levels aloft; and is day-to-day carryover an important feature?
- Is the three-dimensional wind field in the Las Vegas Valley uniform or dominated by local terrain features?
- How representative is the NOAA sounding at Desert Rock of the boundary layer in the Las Vegas Valley?
- How well does the CART ozone forecast model perform in an operational mode?
- Can we distinguish the relative contributions from transport and local emissions to the total ozone burden in Clark County?

In addition, a descriptive analysis of the air quality and meteorology during high ozone periods which occurred over the duration of the 2005 field study is given. Each day on which an exceedance of the 8-hr ozone standard occurred is discussed to some extent. Appendix B presents graphics of ozone concentration contours using various combinations of the CCROPS monitoring network as well as the 24-hr Hysplit back-trajectory and rawinsonde/ozonesonde plots for each day. In addition to exceedance days, plots for the July IOP are also included in the appendix, as this period was particularly representative of conditions for high ozone in the Las Vegas area. Key examples are included in the discussions below.

7.1 High Ozone Events – 2005

Historically, high ozone levels are most frequent in Clark County during June and July. The 2005 ozone season was no exception. **Table 7-1** contains the number of days the 8-hr. ozone standard was exceeded by month as reported by Lehrman, et al and for the 2005 ozone season. The 2005 totals are shown for 1) just the DAQEM network, 2) just the Supplemental network, and 3) both the DAQEM and Supplemental sites combined. There were not any exceedances of the 85 ppb criteria during May in either network. During June, exceedances were measured on the same three days in both networks. In July, DAQEM's network measured exceedances on five days whereas the Supplemental network experienced exceedances on those same five days and on two additional days. August was interesting in that each network caught an exceedance on one day but on different dates. Therefore had the routine network consisted of the set of sites used in both the DAQEM and Supplemental networks, exceedances of the 8-hr ozone standard would have been reported for three additional days.

Figure 7-1 shows daily peak 8-hr ozone levels over the field operations period for the DAQEM network and Supplemental network on separate plots. As can be seen from the figure, there

were four periods during which ozone levels exceeded the 85 ppb standard; June 12, June 29-July 3, July 15-18, and August 6-10. In general, maximum ozone exposure was well represented by the existing DAQEM but there were some notable exceptions.

Table 7-1. Number of Days When Peak 8-hr Ozone was Greater than or Equal to 85 ppb

#Sites	Season	May*	June	July	Aug	Totals
5	1996	1	2	1	1	5
6	1997	1	0	0	0	1
6	1998	0	2	6	0	8
13	1999	1	3	2	0	6
15	2000	0	0	1	2	3
15	2001	0	0	0	3	3
15	2002	0	3	1	2	6
15	2003	2	6	2	1	11
15	2004	2	0	1	0	3
14	2005 DAQEM Sites	0	3	5	1	9
24	2005 with Supplemental Sites	0	3	7	1	11
34	2005 including both networks	0	3	7	2	12

*Supplemental Sites fully operational May 15

Consistent with the Characterization Study, maximum ozone levels in Clark County during the 2005 field study generally occurred in the northwest quadrant of the Las Vegas Valley. However, on nine of the twelve exceedance days, the maximum occurred outside of the area covered by the DAQEM network. The Paiute Reservation site and Indian Springs, both Supplemental sites and further upvalley from Lone Mountain and Joe Neal, usually measured the highest ozone. The following discussion provides a descriptive analysis of and additional details on each of the exceedance periods.

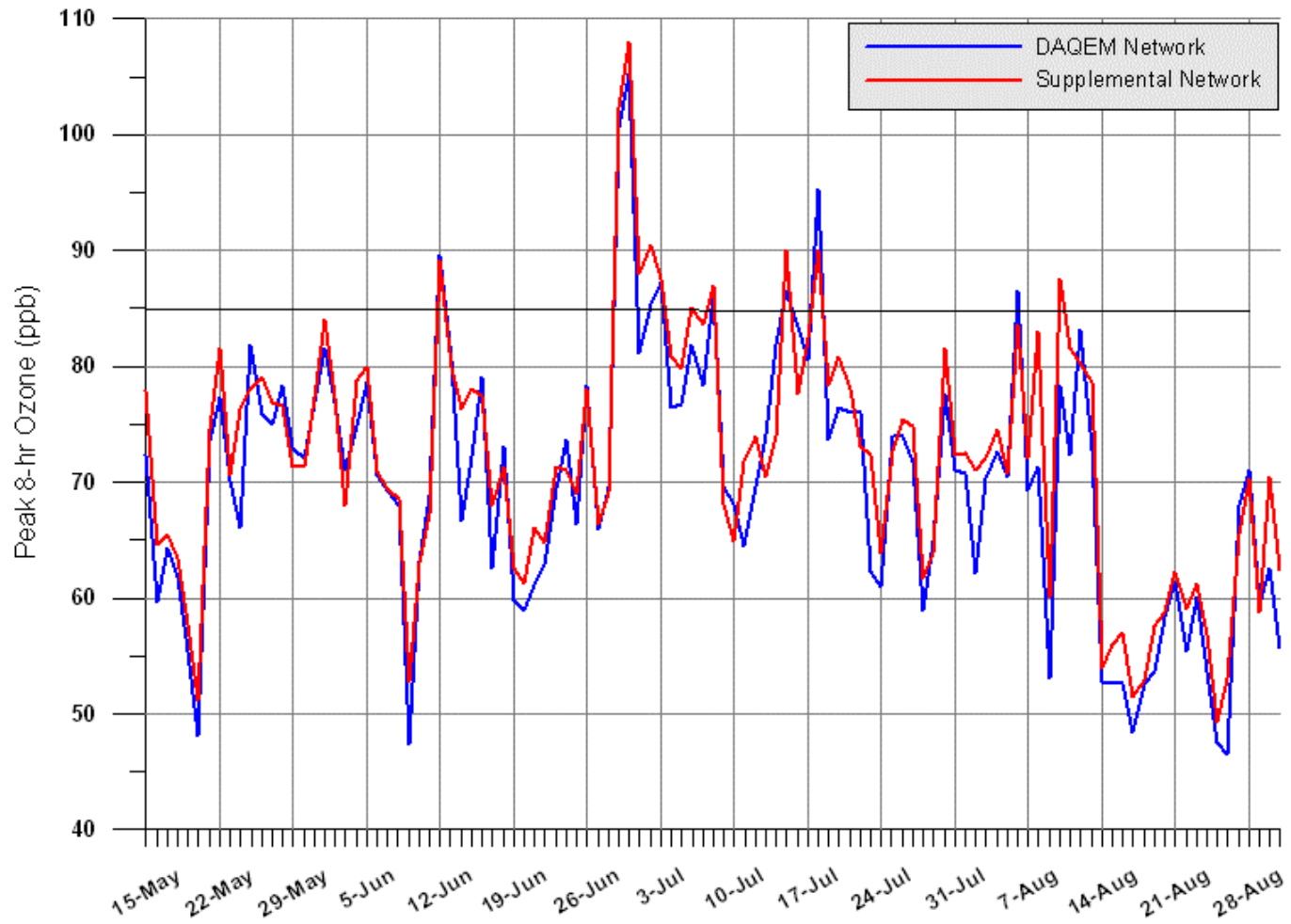

Figure 7-1. DAQEM and Supplemental Networks Daily Peak 8-hr Ozone Concentration

7.2 Saturation Network

Prior to discussing exceedances measured by the CCROPS ozone monitoring network, it is first necessary to discuss in some detail the ozone saturation network developed for CCROPS. The 12-sampler saturation network was operated during four IOP events. When combined with the data obtained from the 13 DAQEM and 10 Supplemental sites, the information enhances the base of information and understanding of the distribution of ozone. While the data from each of the saturation samplers is internally consistent, there are some results that must be explored further to determine if occasional network anomalies may be related to the sampling technique, or are real events that were captured by the additional detail provided by the Saturation network and would be potentially missed by the routine measurements.

The saturation site Sunset Park appears to have fallen into this category. From the peak 8-hr average contour plots, it can be seen that on several occasions ozone at Sunset Park was notably higher than at surrounding sites and frequently recorded the network maximum, producing a singular point on regional ozone contour maps. **Figure 7-2** shows a particularly striking example of this. **Figure 7-3** shows the same data set with the Sunset Park data removed, producing contours more consistent with the regional behavior usually associated with ozone plumes. It should be noted that the low readings at the Losee site (another Saturation site) apparent in both figures cannot immediately be explained, though low values can be the result of scavenging by local sources and thus are more easily explained than high point values.

This ozone behavior necessitated a reexamination of the site calibrations and equipment performance to ensure the validity of the measurement. All aspects of the sensor performance were examined, since the ozone-measuring method used is not a FRM and interferences from other oxidants are known to exist. This also entailed activating the specific instrument used at Sunset Park well after the end of the field program and subjecting it to performance checks against a standard, as well as to possible interferences such as SO₂ and NO₂. The results of the reevaluation of the Sunset Park sampler showed that the calibration factors used during data reduction were valid and did not shift significantly over time, and no significant interference effects were noted.

Sunset Park is immediately adjacent to the southeast perimeter of McCarran airport. The site was approximately 2 km southwest from runway 27 which, based on prevailing winds, is likely the most used runway during the daytime. The nearest site to Sunset Park was Star Nursery, located approximately 10 km to the west. (refer to the map showing site locations on Figure 2-2). Star Nursery was one of the saturation sites and employed the same instrumentation. Ozone levels measured at Star Nursery were usually consistent with regional contours. Paul Meyer is the closest DAQEM site, employing a reference method ozone analyzer.

Ozone at Sunset Park, Star Nursery, and Paul Meyer are compared in **Table 7-2**. Statistics are given in the table for 8-hr averaged ozone levels for all days that the saturation network was operational. The “daytime” values consist of ozone occurring from 10-18 PST when photochemistry is most active. The “nighttime” values include the hours from 22 to 07 PST when photochemistry is inactive. If other oxidants are interfering with the saturation sampler, unless they are also photochemical, they should interfere at nighttime as well as during the day. From the table, it can be seen that night readings at Sunset Park are skewed lower than those at Star Nursery, and their averages are within 1 ppb. Lower nighttime levels are observed at the Sunset Park site

that would be consistent with greater concentrations of nocturnal ozone reducing emissions. However, the nighttime readings at Paul Meyer are even lower, and are more typical for the urban ozone sites. This would tend to imply that artificially high readings due to some sort of an instrument artifact might be affecting the Sunset Park sampler. The higher nighttime concentrations at Star Nursery could simply be due to location in a less urban area.

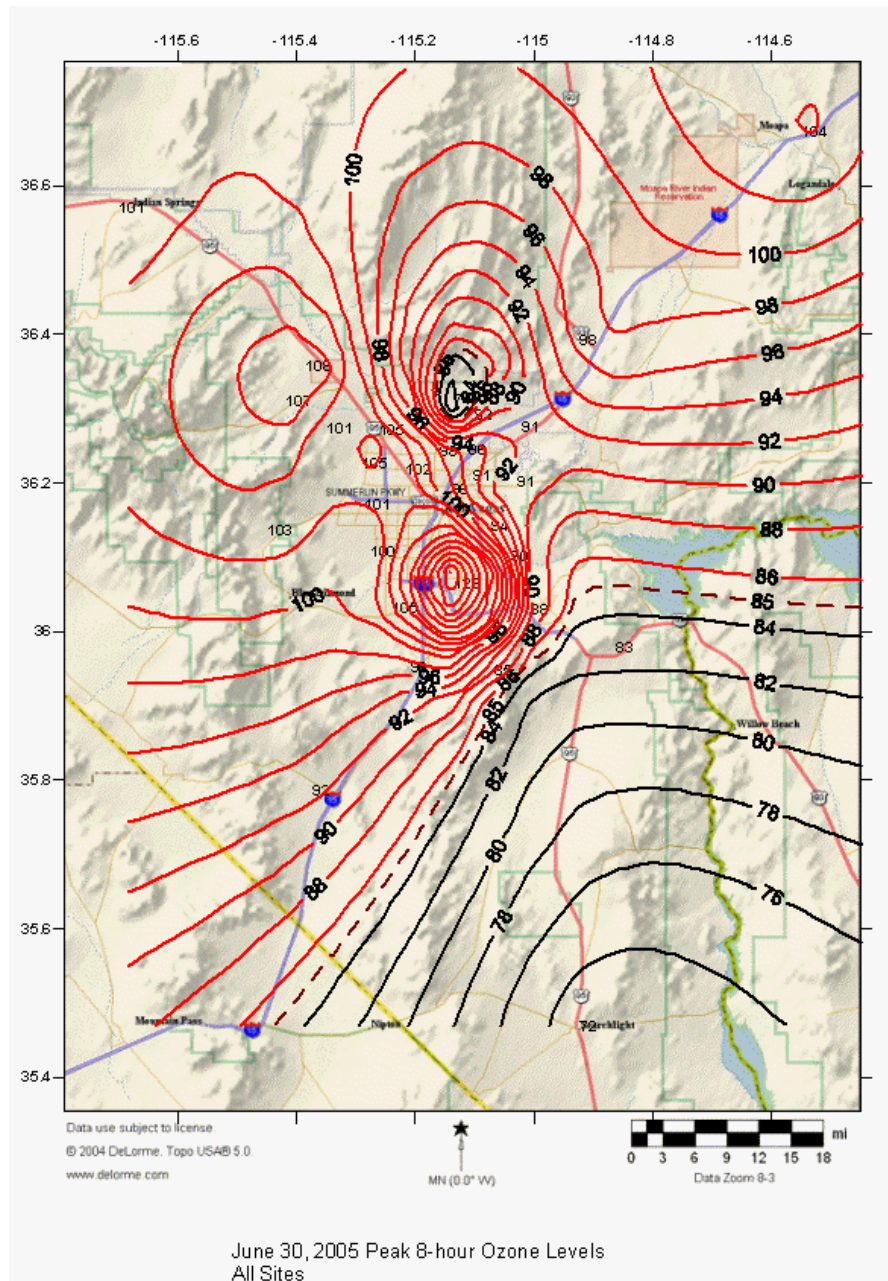

Figure 7-2. Maximum 8-hr Ozone Contours for June 1 at All Sites

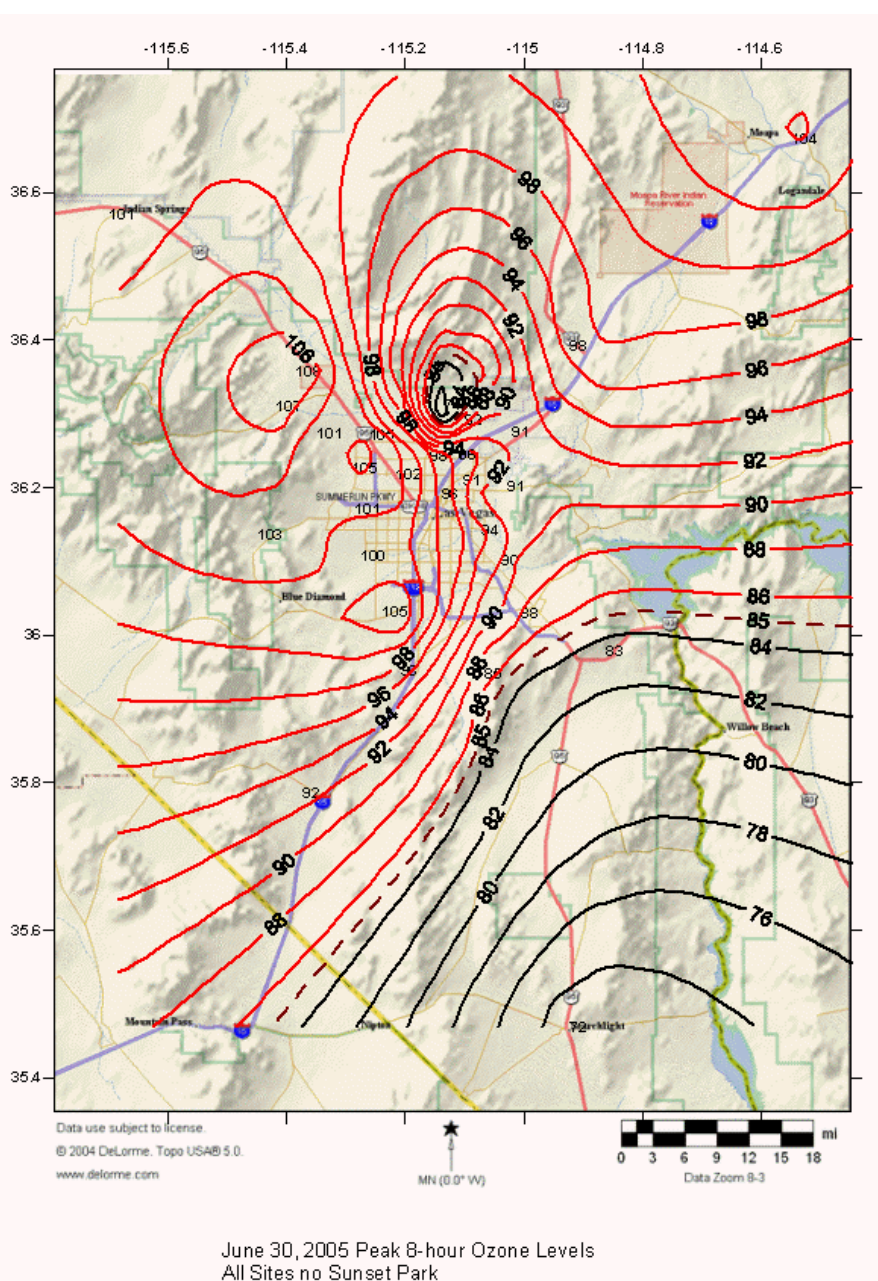

Figure 7-3. Maximum 8-hr Ozone Contours-Without Sunset Park

Table 7-2. Comparison of Concentrations Versus Sunset Park

	Sunset Daytime	Sunset Nighttime	Star Daytime	Star Nighttime	PMeyer Daytime	PMeyer Nighttime
Average	83	47	76	48	65	23
Maximum	129	82	108	73	100	55
Minimum	60	5	55	11	37	5
1stQuartile	73	35	68	42	55	14
Median	80	45	75	49	63	18

units are ppb

Thus, there is no direct instrument-related evidence at this time to discount the apparent singularity or local ozone peaks at Sunset Park. Readings from Star Nursery are also frequently high, so it appears likely that high concentrations are possible in this region, though possibly not to the magnitude recorded. A cursory review of winds shows that the unusually high readings at Sunset Park are more pronounced when winds are from the east, drawing air from the urban area, then when from the south or southwest, from less urban areas. Nevertheless, the resulting concentration contours are somewhat inconsistent with current understanding of ozone plumes, and the possibility of some sort of positive offset, either from interferences or from an indefinable instrument problem, remains. Our recommendations will include suggesting additional monitoring at Sunset Park with more standard equipment during the upcoming ozone season. Further analysis of winds in the vicinity may also shed light on the issue. However, so as not to confuse observations, the Sunset Park data has been removed from the following discussions.

7.3 Summary of Exceedances

As noted above, exceedances of the 8-hr ozone standard were recorded on nine days by the DAQEM monitoring network. The CCROPS Supplemental monitoring network recorded exceedance levels on an additional three days. Finally, the saturation monitoring network recorded concentrations above the 8-hr standard on 11 additional days. However, due to the experimental nature of the saturation monitoring methodology, the absolute accuracy of the measurements is still under review.

A primary goal of the 2005 study was to provide a data set that provides additional insight into the relationship between meteorology and air quality in Clark County. More specifically, can the relative contributions of interbasin transport and local emission sources be determined, and, if so, do we understand the critical atmospheric processes involved.(i.e. transport and dispersion). It is beyond the scope of the current project to completely analyze the copious amount of data collected. However, as an initial attempt at answering this question, the data were examined using the following five approaches:

- Meteorological conditions and ozone concentrations on and around the days of the exceedances were input to the CART model generated as part of the Clark County Ozone Characterization Study. The CART model separates the exceedances into categories that can basically be distinguished as favoring transport or favoring local contributions.
- The Ozone Characterization Study demonstrated that the timing of the ozone peak could provide information as to the cause of the exceedance. High concentrations due to transport can occur any time of the day and ozone levels can rise very rapidly within a brief period. Often a peak in surface ozone is observed during the night or before noon, due to mechanical or convective mixing entraining ozone aloft, either transported or carried over from the prior day reach the surface. Locally generated ozone reacts from accumulated precursors and insolation over the course of the day and will peak in the afternoon exhibiting a gradual buildup. One-hour data from the DAQEM and Supplemental network were reviewed and the median time of the concentration peak was determined at each site for each of the exceedance days. Ozone peaks at noon or earlier were considered indicative of transport. Afternoon ozone peaks could be owing to local sources exclusively or could be a combination of local sources and transported pollutants.

- Conditions at the Jean site (DAQEM) were reviewed for each exceedance day. If the peak 8-hr ozone concentrations at Jean was nominally high (greater than 75 ppb) and the winds recorded at the Sloan Supplemental site had a predominate westerly component, it was concluded that the high Jean concentration could not have been influenced by the greater Las Vegas urban area, and the high concentration was therefore due to interbasin transport from California.
- 24-hr back trajectories were generated for each exceedance day using the Hysplit model, nominally based on a 10-meter ending height at the North Las Vegas airport at 14 PST. Ozone data around the apparent source-area of the trajectory were reviewed for the occurrence or not of high levels of ozone. If concentrations greater than about 80 ppb were noted at these source areas on the day-before the Clark County exceedance, transport was considered to be a likely possibility.
- Data from two of the Supplemental network sites were reviewed as an initial effort to estimate the contribution of the greater Las Vegas urban area to the ozone concentrations in Clark County. Data for 05 PST from the Black Mountain site, which was on a mountain top and above the Valley nocturnal boundary layer, was considered representative of the ozone pool aloft and available for adding to the current day's ozone burden. This site is located well above the valley floor and away from ozone scavenging mechanisms. Data from the Paiute site was selected as most representative of the regional ozone maximum concentrations. This site exceeded the 85 ppb standard on nearly all the exceedance days and most often had the highest concentrations (see Table 7-2). Comparing the data from the two sites, the 8-hr peak concentration at Paiute is on average 10.6 ppb higher than the 05 PST 1-hr average at Black Mountain, with a standard deviation of 11.7. Using of limit of 22 ppb derived from the average difference plus one standard deviation, it was assumed that differences greater than 22 ppb are indicative of an above average local contribution to the ozone burden at Paiute, whereas lower values reveal that relatively high ozone concentrations were already present, either from transport or from the previous day.

In addition to the above, meteorological data were reviewed and compared with results and conclusions from the Ozone Characterization Study. CCROPS forecast notes were also reviewed.

Table 7-3 summarizes the 2005 exceedances and the results from the above analysis. Each of the exceedance days are briefly discussed below, with the principal goal of determining whether they were transport or locally driven. The designation of "transport" versus "local" is, of course, one of relative distinction. All days will likely have some transport component and some local contribution component. The exceedances on July 2 and July 18 are discussed in more detail, as they are classic examples of a transport scenario and local contribution scenario, respectively. These two days also were episode-mode days, when additional data were available.

Table 7-3. Summary of 2005 Ozone 8-hr Exceedances

	12-Jun	29-Jun	30-Jun	1-Jul	2-Jul	3-Jul	6-Jul	8-Jul	15-Jul	18-Jul	6-Aug	10-Aug
Max 8-hr avg (ppb)- DAQEM network	90	101	105	81	85	87	82	86	87	95	87	78
# Exceedances - DAQEM network	3	12	11	0	1	1	0	1	4	5	2	0
Max 8-hr avg (ppb) - supplemental network	89	102	108	88	91	88	85	87	90	90	84	88
# Exceedances - supplemental network	1	7	8	1	2	2	1	2	1	2	0	1
Max 8-hr avg (ppb) - saturation network		122	129	99	90	80			94	105		
#Exceedances - saturation network		9	10	3	4	0			3	6		
Max 8-hr avg (ppb) - entire network	90	122	129	99	91	88	85	87	94	105	87	88
#Exceedances - entire network	4	28	29	4	7	3	1	3	8	13	2	1
Maximum Ozone Location	Lone Mtn	Paiute Res	Paiute Res	Indian Sprgs	Indian Sprgs	Paiute Res	Black Mtn	Paiute Res	Paiute Res	Lone Mtn	Lone Mtn	Paiute Res
CART model	Transport?	Local	Local	Transport?	Transport	Transport?	?	Transport?	Local?	Local	?	?
Peak hr < 1300 = transport	Local	Local	Transport	Local	Local	Transport	Local	Local	Local	Local	Local	Local
Jean conditions	Local	Local	Local	Local	Transport	Transport	?	Local	Local	Local	Local	Local
Back trajectories	Local	Local	Local	Transport	Transport	Transport	Both	Transport	Local	Local	Local	Local
Paiute/Black Mountain difference (ppb)	13	32	32	10	4	15	3	16	35	23	37	43
	Both	Local	Local	Transport	Transport	Both	Transport	Both	Local	Local	Local	Local
Consensus	Local	Local	Local	Both	Transport	Transport	Both	Both	Local	Local	Local	Local

Note: For CART model, "?" indicates that not all CART criteria were specifically satisfied, but results leaned towards this conclusion.

June 12

While the CART models pointed toward this exceedance being likely due to transport, primarily because of higher regional mid-day wind speeds, the back-trajectory does not really support this. Concentrations in Jean were reasonably high (79 ppb), but winds at Sloan were from the northwest during much of the day, indicating that the high concentrations at Jean were more likely due to the Las Vegas urban plume.

June 29 and 30

It is unfortunate that wildfires were burning in and around the area on these two days, as they both have the earmarks of being classic, local contribution driven days - high pressure, light regional winds, the classic nighttime downslope winds/ daytime upvalley winds directing the urban plume to the northwest, and low RH both at the surface and aloft. Furthermore, June 29 shows hourly ozone peaking in the afternoon with peaks at downwind sites occurring a couple of hours later, consistent with a “local” scenario. The early peak hour on June 30 is almost certainly due to morning entrainment of carryover from the previous day, rather than to transport from elsewhere. As shown in Table 7-3, this period essentially met all of the criteria for the “local” scenario, and would likely have experienced exceedances without the smoke impact. As it stands, these days will have to live with an asterisk, due to the likely but probably unquantifiable contribution by the smoke. These two days are discussed in more detail in Section 7.3.

July 1

The one exceedance experienced this day was measured at the Paiute site, and was not seen by any DAQEM sites. Transport indicators are mixed for this site, with the possibility of both significant transport and local contributions. The back-trajectory appears consistent with a transport scenario. Although Jean concentrations were high (81 ppb), the winds at Sloan were light and variable. Under those conditions, transport into the Valley from the southwest is not certain.

July 2

Conditions on this day were classic for a transport scenario, as demonstrated by the back-trajectory. The peak 8-hr concentration at Jean was 85 ppb, and indeed, Jean was the only DAQEM site to report an exceedance. With southwest winds dominating during the exceedance, the source of the exceedance is quite obviously not the Las Vegas urban plume. As can be seen in **Figure 7-4**, exceedances in the CCROPS monitoring network occurred solely on the very western edge of the study area, well away from the urban area. **Figure 7-5** shows the back-trajectory analysis for the day, further inferring that the strong southwesterly flow had transported high ozone concentrations from the California desert region, which had high ozone concentrations the previous day. **Figures 7-6 and 7-7** are ozonesonde profiles from the CCROPS site at the North Las Vegas airport for 6 AM and 10 AM on July 2, respectively. At 6 AM a reservoir of ozone and near-exceedance concentrations was poised above North Las Vegas, separated from the surface by a notable inversion. By 10 AM, the inversion had eroded, providing a mechanism to mix the reservoir of ozone down to the surface. However, low-level winds at this time were already pushing the plume to the northwest, impacting the Indian Springs site as well as the Red Rock and Kyle Canyon saturation sites.

This exceedance is further discussed in Section 7.9 the section presenting results from the aircraft measurements, which further supported transport on this day.

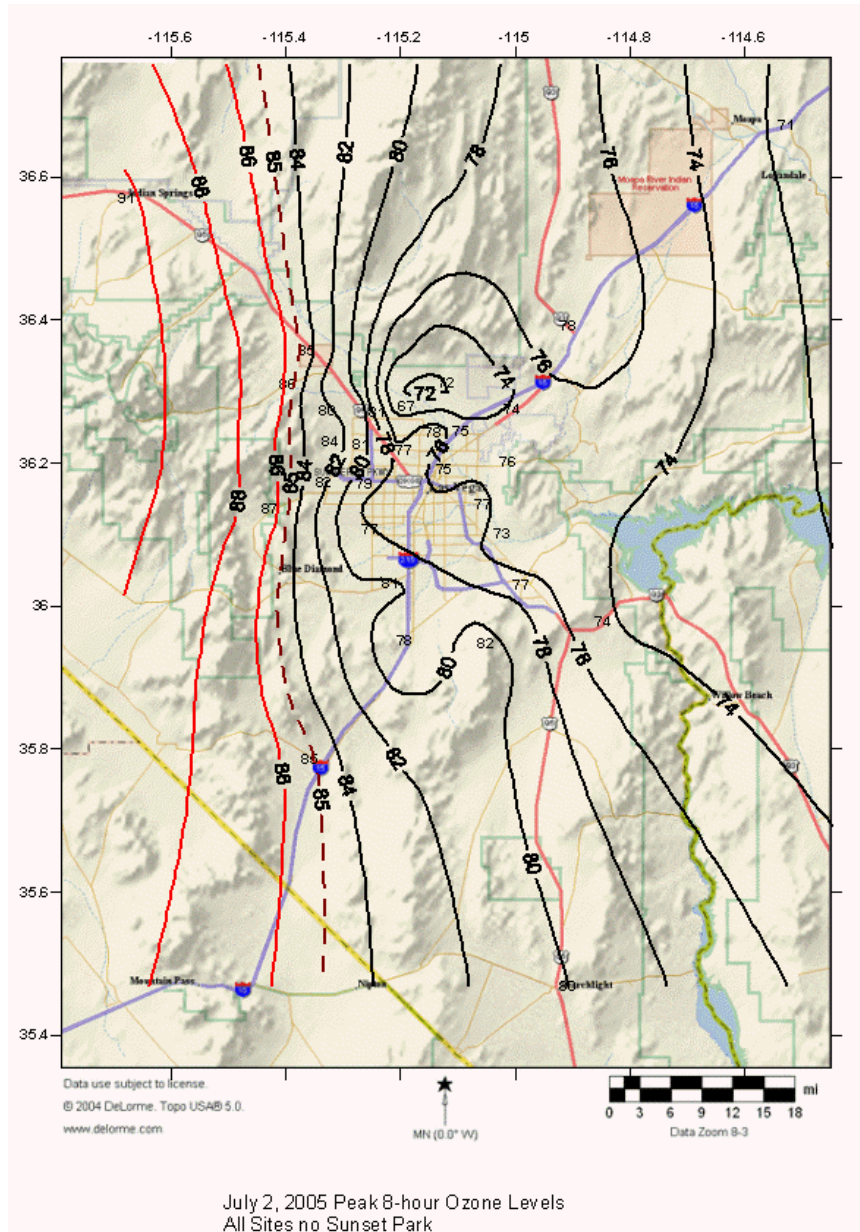
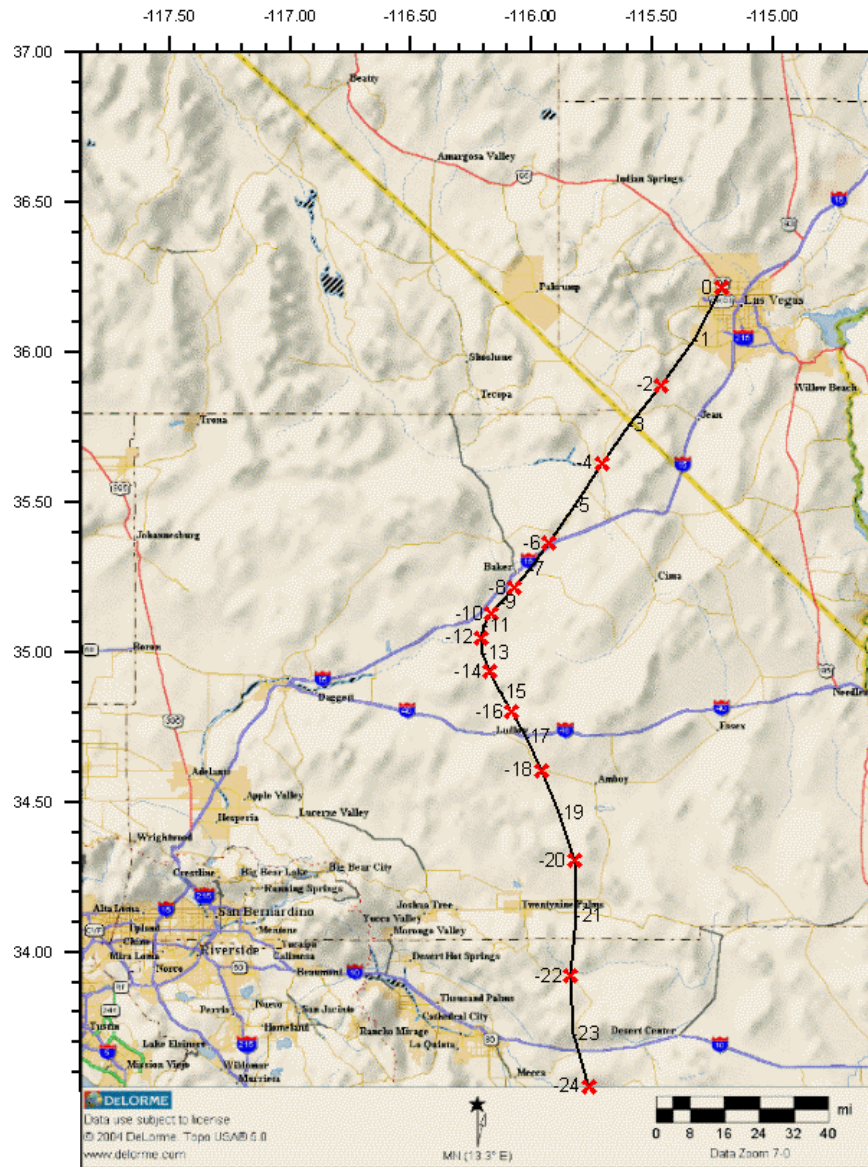

Figure 7-4. Maximum 8-hr Ozone Levels for July 2



Backward Trajectory Ending at 14 PST July 02, 2005
Hours prior to end point shown

Figure 7-5. Back-Trajectory Analysis for July 2

July 3

July 3, another apparent transport day, was similar in most ways to July 2. However, the back-trajectory originated more from the west than from the south inferring the southern San Joaquin Valley as the possible source.

July 6

The Black Mountain site was the only site in the network to record an exceedance this day, demonstrating the unique information gained from monitoring aloft when the

atmosphere is stable. The 8-hr exceedance, while technically occurring during July 6, actually consisted of the last hour on July 6 and the first seven hours on July 7. This nighttime occurrence therefore was due entirely to an elevated reservoir of ozone separated from the surface by the nocturnal inversion. This elevated plume apparently passed the Las Vegas Valley while decoupled from the surface boundary layer. As such, no populated areas of Las Vegas were impacted, and the fact that the DAQEM network did not detect this “exceedance” is for the most part inconsequential.

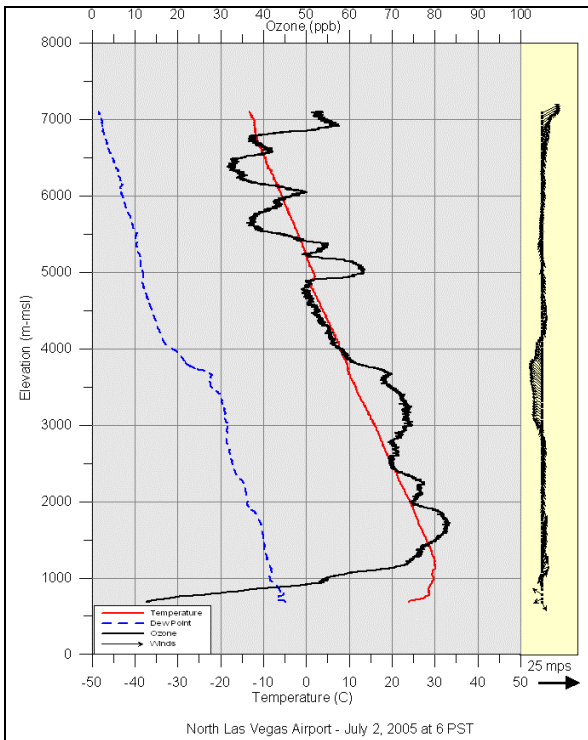

Figure 7-6. July 2, 6 AM Ozonesonde

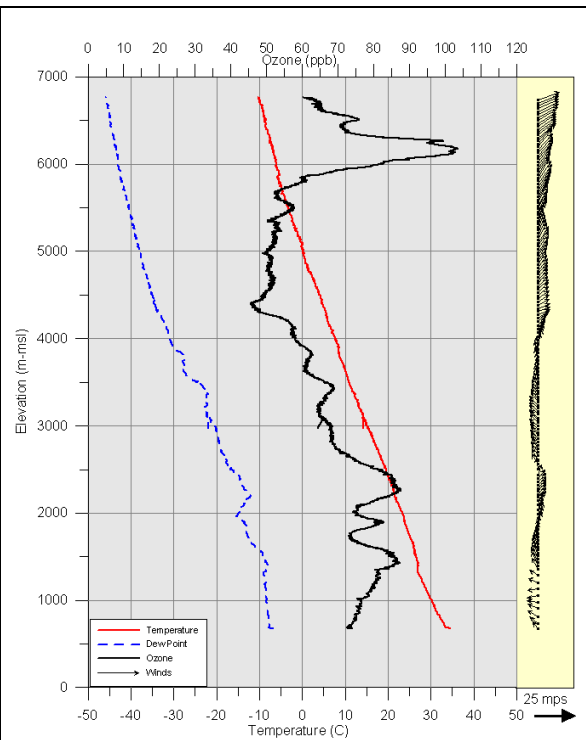

Figure 7-7. July 2, 10 AM Ozonesonde

July 8

Both transport and local contributions appeared to play a significant role in the July 8 exceedance. Both the CART model and the back-trajectory analysis imply contribution from transport. However, the late peaking of concentrations and a significant increase in concentrations differences between Black Mountain and Paiute imply that local contributions were also important.

July 15 and July 18

These periods were dominated by light and variable winds - classic conditions for an exceedance dominated by local contributions. This is demonstrated by the air mass trajectory for the seven hours immediately preceding the July 18 exceedance, which can be seen in **Figure 7-8**. **Figure 7-9** shows the maximum 8-hr ozone contours for the July 18, which is characterized by a plume of higher concentrations pushed to the northwest

by daytime upvalley winds. Again, this is a classic local-contribution scenario as described in the Ozone Characterization Study.

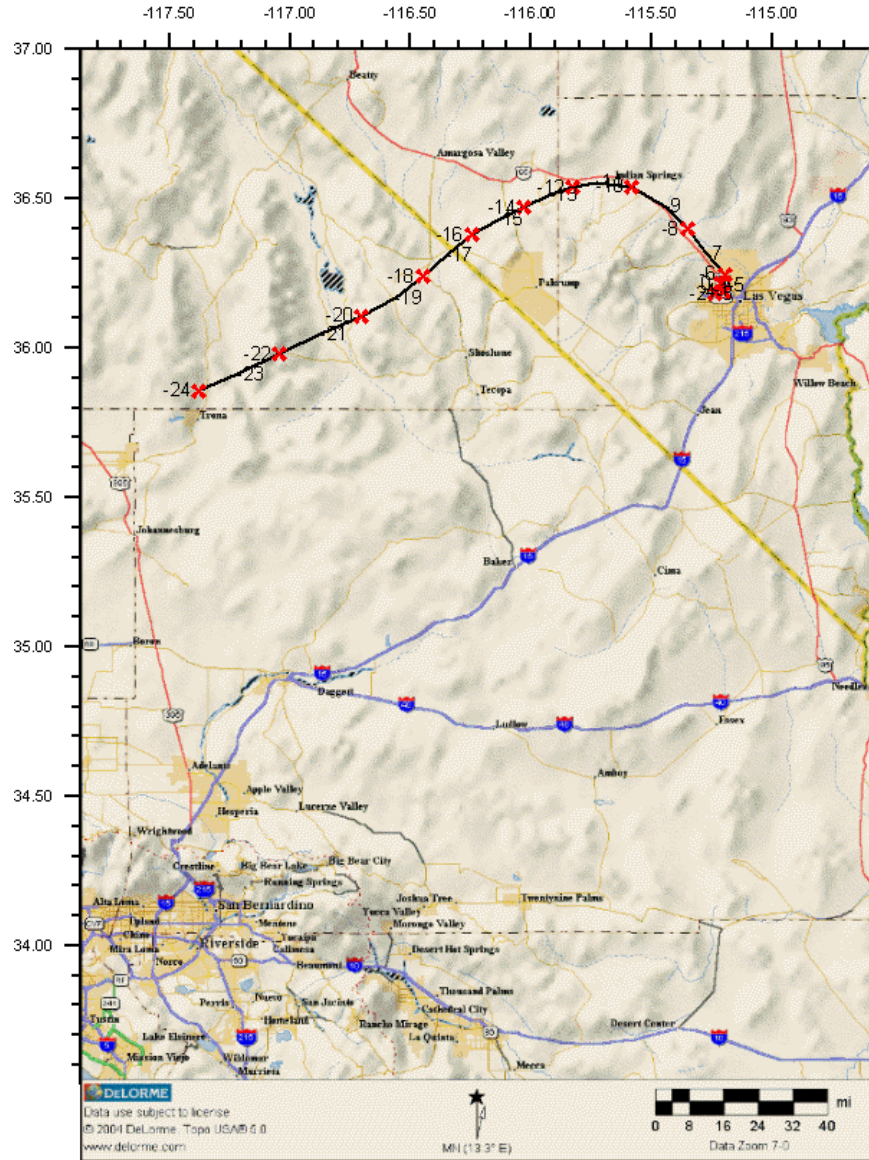

Backward Trajectory Ending at 14 PST July 18, 2005
Hours prior to end point shown

Figure 7-8. Back-Trajectory Analysis for July 18

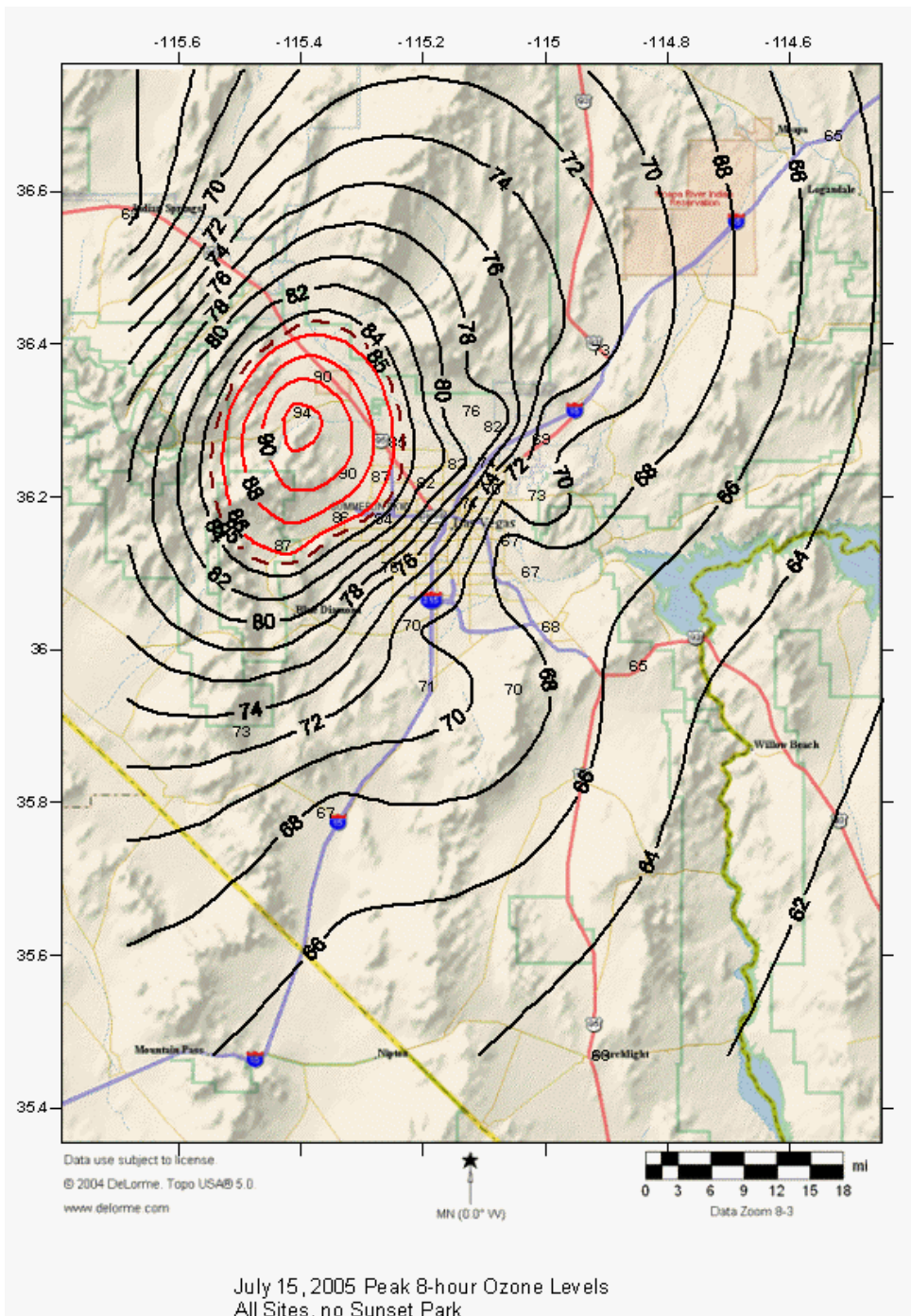

Figure 7-9. Maximum 8-hr Ozone Levels for July 15

August 6 and 10

These two exceedance days were similar in almost all respects. The 8-hr ozone standard was barely exceeded on both days, and only at one site. While the CART model did not provide any hint towards the principal source of the exceedances, all other

criteria indicate that local emissions were the predominant source causing the exceedance. Trajectories for both days show only light winds and meandering plume within the Las Vegas Valley. The difference between Black Mountain and Paiute readings is particularly large.

7.4 Wild Fire Events

CCROPS forecasters had predicted that the last part of June would be conducive for high ozone potential in Clark County. Consequently, Intensive Operation Period monitoring was in effect when two major smoke events occurred; the first beginning June 23 as a result of the Goodsprings fire located approximately 20 km southeast of Las Vegas, and the second on June 29 and 30 due to wildfires in southern California and southern Utah that inundated the area with smoke (**Figure 7-10**). The latter was associated with widespread exceedances of the 8-hr ozone standard throughout Clark County, with 8-hr concentrations reaching 108 ppb, among the highest ever recorded in this region (**Figure 7-11**).

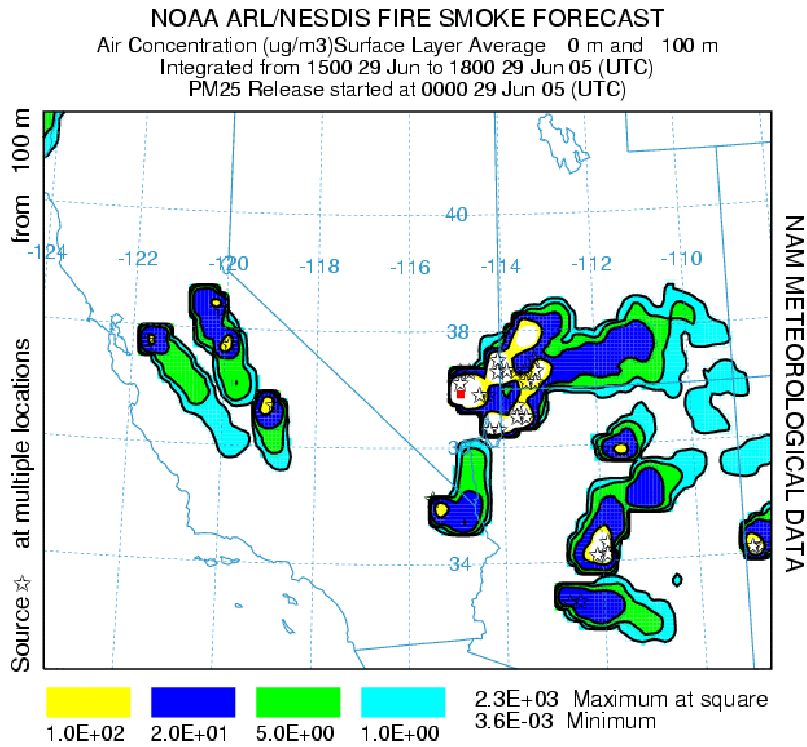

Figure 7-10. NOAA Smoke Forecast for Afternoon of June 29 (Star's designate active fires)

Preliminary analysis of the CCROPS data has shown apparent relationships between ozone concentrations and wildfire smoke. This relationship appears to be dependent on the age of the constituents that comprised the smoke plume. As in an urban plume, reactants in the fire plume titrate ambient ozone. Thus near the wild fire ozone may be

less than regional background levels. Conversely, as the fire plume ages in which ozone production has been active, ozone levels increase to above background.

The Goodsprings fire on June 23 produced a plume that, when in the greater Las Vegas area, was still in its infancy with regard to precursor conversion to ozone.

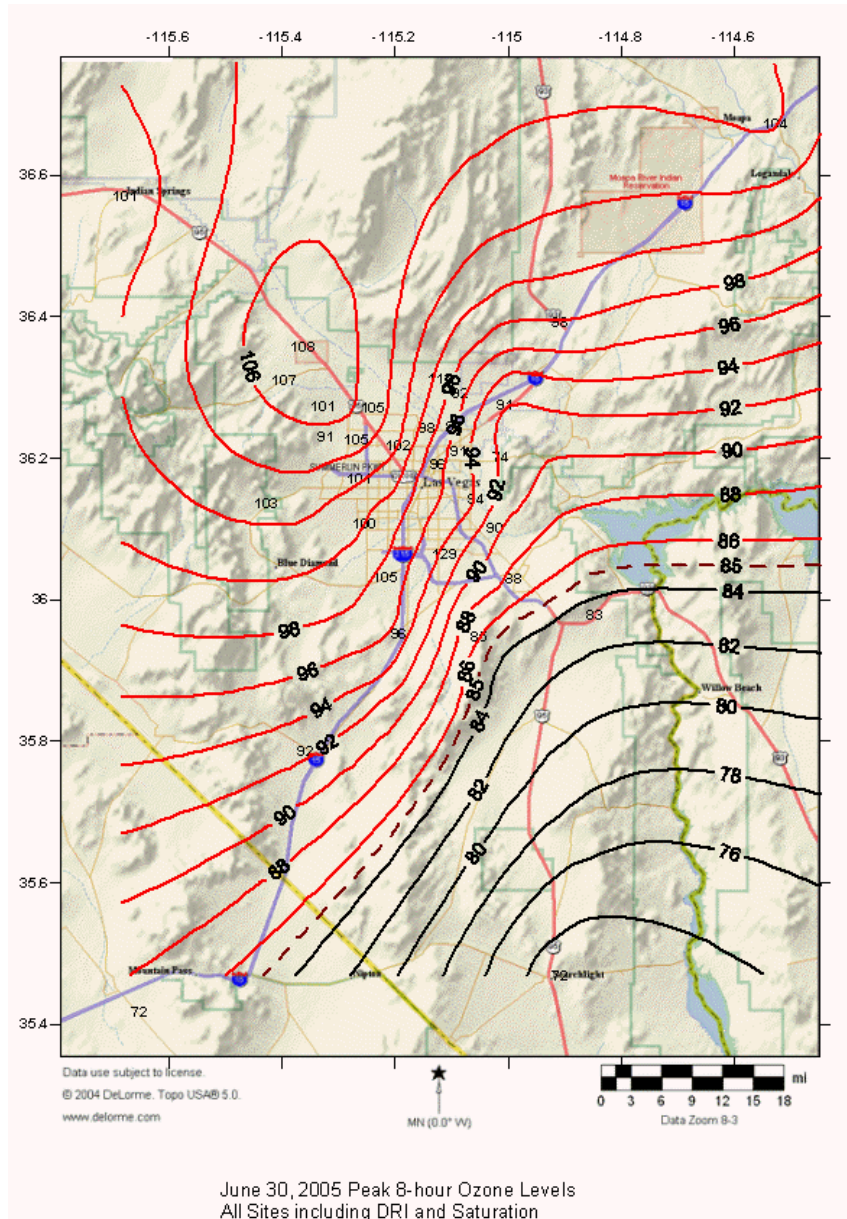

Figure 7-11. Maximum 8-hr Ozone Levels on June 30

A glider equipped with an ozone monitor conducted soundings during this period. The glider operated out of the Jean airport, only a few kilometers from the Goodsprings fire. **Figure 7-12** shows a plot of the glider ozone profile taken during the fire. Based on observations from the glider pilot, entering the plume from the Goodsprings fire was accompanied by a significant decrease in ozone concentrations by titration. In contrast,

when the glider was above the Goodsprings plume in air that back-trajectory analysis indicates came from fires near Joshua Tree in southern California, ozone concentrations were clearly greater above those near the surface.

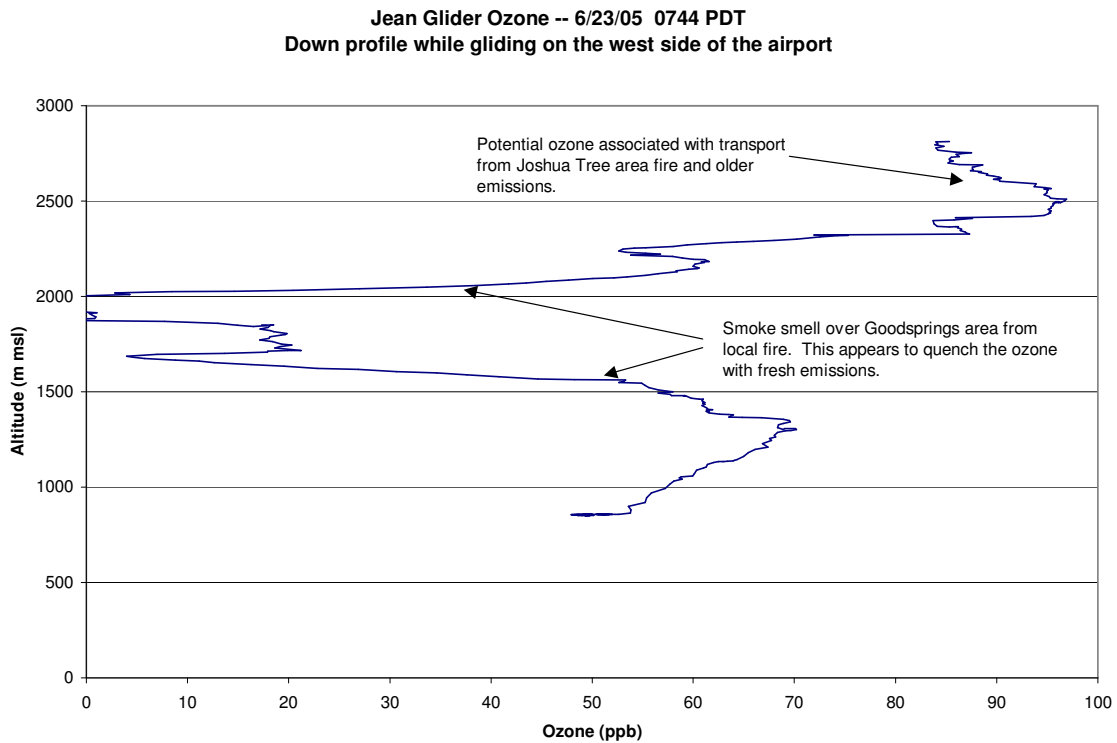

Figure 7-12. Ozone Profile for Morning of June 23 Near Goodsprings Fire

This association of higher ozone concentrations with wildfire smoke plumes was further demonstrated during another aircraft sounding on July 1 as the smoke was beginning to clear after the June 29 and 30 fire event (**Figure 7-13**). For this sounding, the tow aircraft was equipped with a portable light-scattering PM_{10} analyzer as well as ozone monitor. The sounding clearly shows an increase in measured ozone concentrations as the aircraft encounters the remnants of the smoke plume, indicated by a corresponding increase in PM_{10} concentrations.

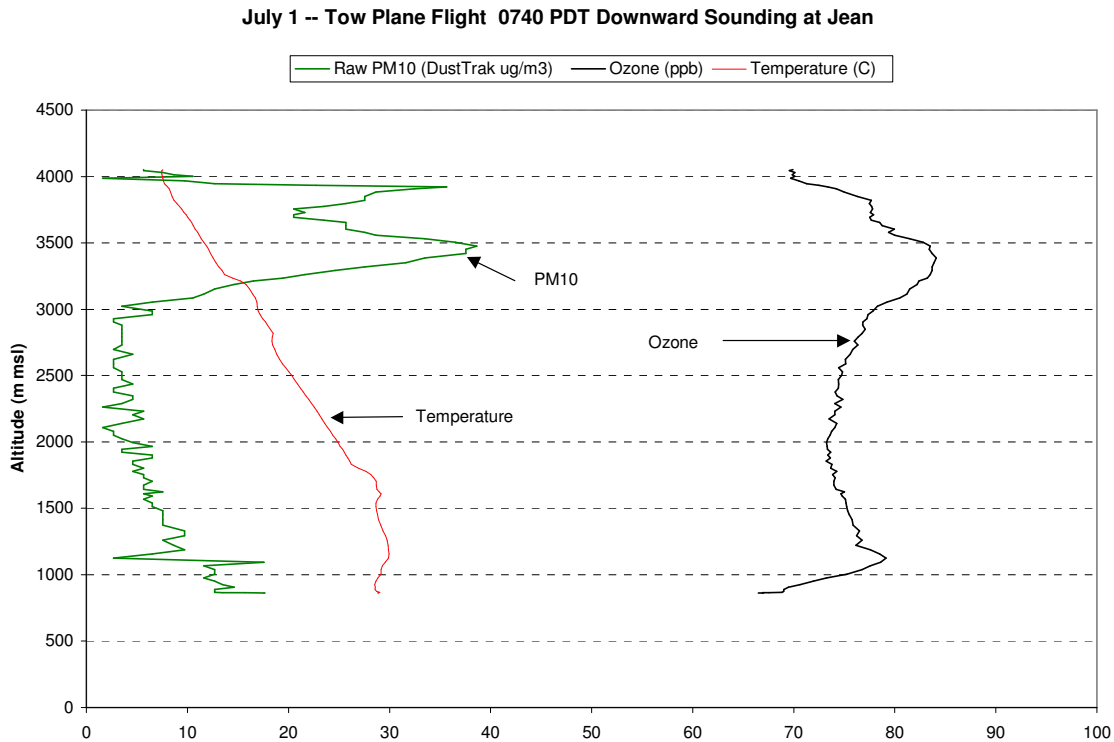

Figure 7-13. Ozone and PM₁₀ Profile for Morning of July 1

The above is just a cursory analysis of the CCROPS data during these wildfire events, using only one of the many measurement platforms available during these periods. Additional analysis of surface PM₁₀, PM_{2.5}, VOC and NO_y concentrations may better define the extent of the smoke events and their correlation with ozone concentrations. Investigation into the source and age of the events through review of fire data and meteorology is also needed. Furthermore, based on conclusions from the Ozone Characterization Study, initial analysis of the June 29 and 30 event has indicated that these days had all of the characteristics of high ozone concentration potential, even without the smoke. Determining the extent that the smoke played in causing the record exceedances remains a critical goal in understanding ozone in Clark County.

7.5 Forecasting Ozone in Clark County

The forecasting protocol used during CCROPS was described in Section 4. The following summarizes our observations relating to the forecasting effort.

- In general, the daily operational forecast was issued in a timely fashion everyday of the project, and proved to be a critical in the determination of each day's operational monitoring strategy. Inevitable professional disagreements between forecasters were discussed until a consensus forecast was decided.
- The 2005 ozone season in southern Nevada appears to have been one of anomalies. Very few clear-cut interbasin transport events took place in the manner reported in the Ozone Characterization Study. There were also at least two unusually long "clean" periods resulting from troughing or monsoonal activity

that precluded intensive monitoring activities for extended periods. Conversely, an ozone episode took place in late June that was characterized by some of the highest concentrations ever recorded in Clark County. This event was associated with a severe wildfire smoke event that also produced high PM concentrations. Another “surprise” single day ozone event took place on a Sunday in early June that appears to be associated with weekend tourist traffic leaving of Clark County during meteorological conditions particularly conducive to the development of high ozone.

- Overall, the forecast accuracy for the project met project expectations. Intensive monitoring operations were initiated prior to the severe smoke event in late June. Only the “Sunday Surprise” on June 12 was totally missed, resulting in only routine monitoring data coverage (both the DAQEM network and the CCROPS supplemental network). In addition, the long periods when good air quality was present and even when marginally poor low ozone events occurred was recognized early enough to minimize non-productive monitoring effort.
- The general success of the specialized operational forecasting for this project indicates that the number of meteorological factors associated with ozone and non-ozone events have been sufficiently identified. Hopefully, after detailed analyses of the data collected during the field study is complete more improved forecasts will result. The short and medium range NWS forecast products for the most part proved to be accurate and reliable tools for use in generating the specialized pollution forecasts. The main problems were the result of unknown or unforeseen precursor and ozone sources (e.g. smoke events), and not having a clear understanding of the daily variations of local emissions, and their impacts on regional ozone.
- The CART models developed during the Ozone Characterization Study did a mixed job of predicting ozone exceedances. Of the eight exceedance-days recorded by the DAQEM monitoring network, four of the exceedances fit the developed CART criteria. However, in most failed cases, conditions failed the criteria only by a slight amount, and refinement of the CART models will likely improve forecasting accuracy. There was also good agreement between the CART models and the forecaster regarding whether the ozone burden would be dominated by interbasin transport or local sources.

7.6 Adequacy of the DAQEM Ozone Measurement Network

As noted at the beginning of this section, a major goal of the study was to determine the adequacy of the DAQEM’s ozone monitoring network. There was concern regarding the current networks ability to measure the peak ozone levels occurring in the northern sectors of the study area. The CCROPS network proved worthy to address this issue as demonstrated by **Figure 7-14**. Contours on this figure were based on the DAQEM network exclusively and shows the high ozone concentration contours remaining open in the northwest portion of the Valley as there are no measurements beyond Lone Mountain-Joe Neal sites. CCROPS Supplemental sites were placed at Paiute and Indian Springs in the northwest, and at Speedway and Moapa in the northeast. **Figure 7-15** shows how these additions altered the areal ozone distribution analysis. Contours are now closed in the northwest, clearly defining the extent of the high ozone. The Paiute site repeatedly recorded some of the highest, if not the highest, readings on

a given day. In addition, saturation samplers in the northern areas of North Las Vegas and the foothills along the west and northwest regions of the study area further defined the extent of the plume on several days, as shown in **Figures 7-16 and 7-17**.

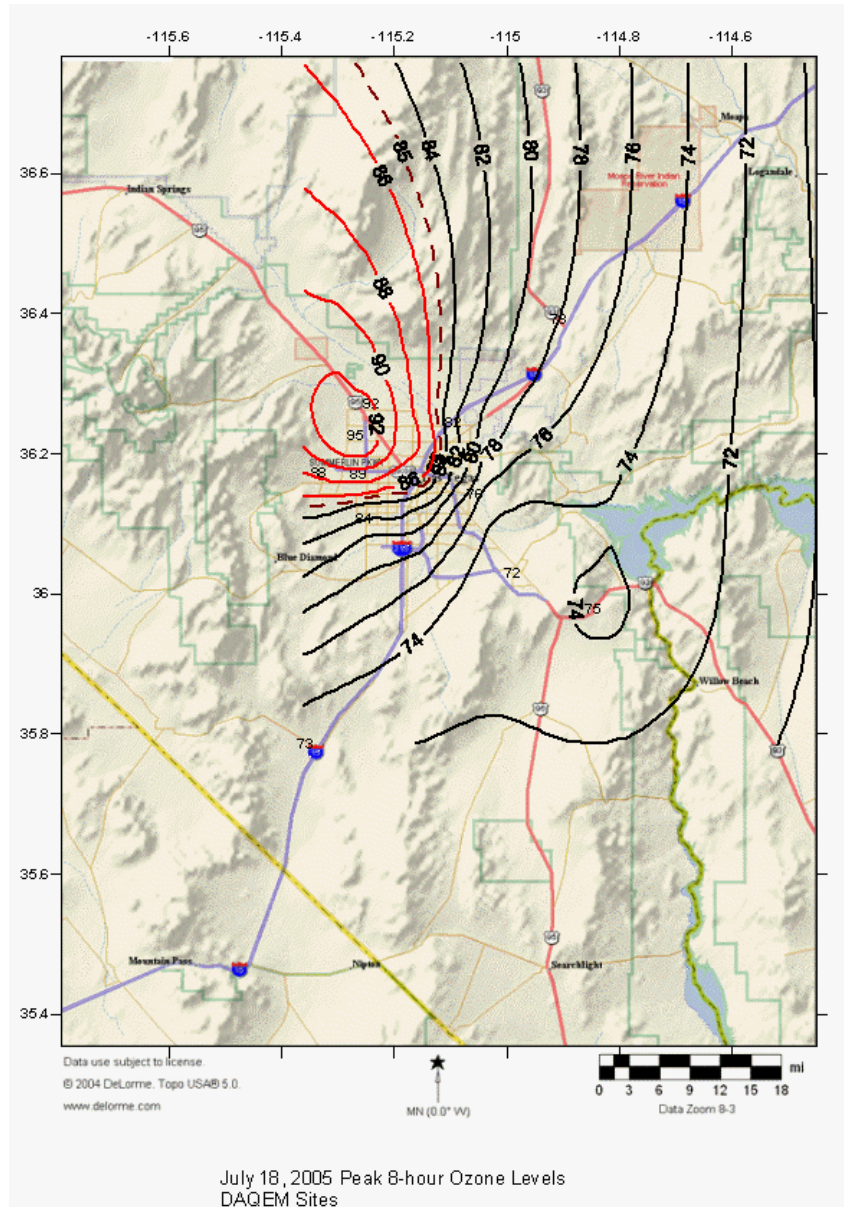

Figure 7-14. Maximum 8-hr Ozone Levels-Only DAQEM Sites

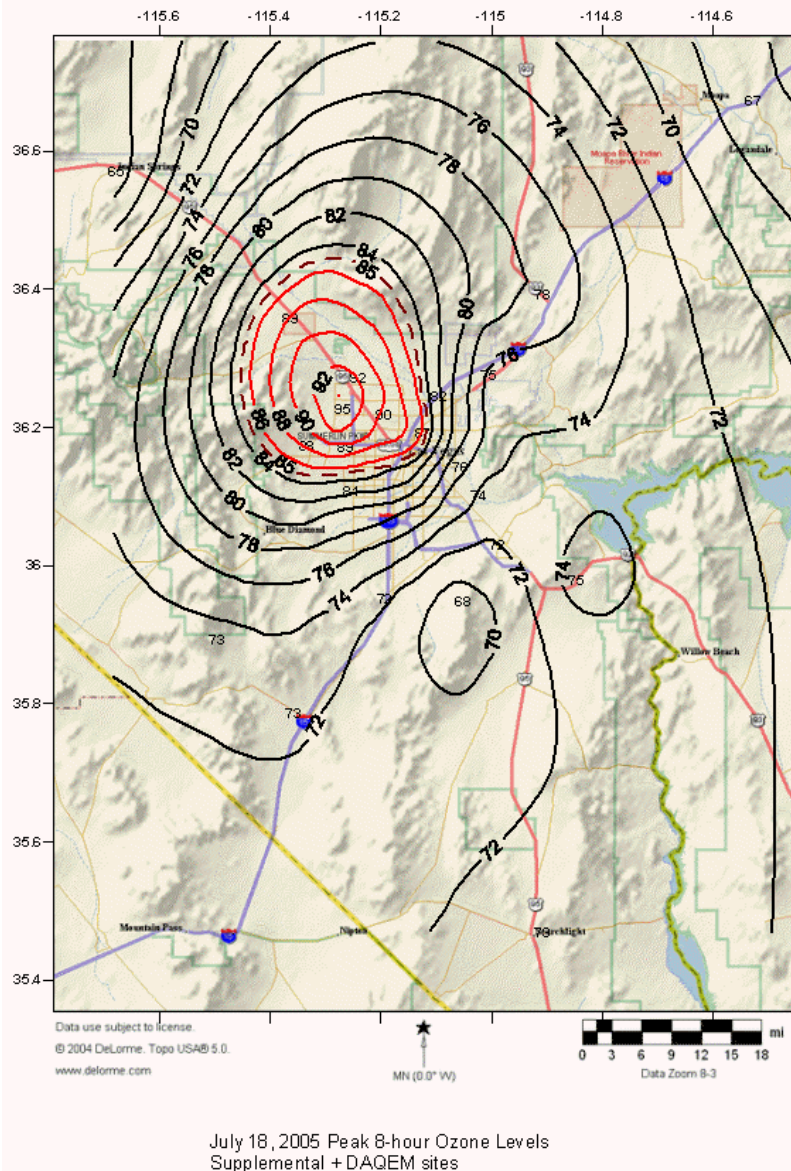

Figure 7-15. Maximum 8-hr Ozone Levels for July 18 at Both DAQEM and Supplemental Sites

Figure 7-18 is a composite representation of all high ozone days (greater than 70 ppb) during the IOPs, when the complete CCROPS ozone network was operating, including the saturation samplers. This figure shows daily data for each site compared against the regional average of all sites. Daily differences between the peak ozone and regional average were then averaged, producing the values presented on Figure 7-18. In this manner, positive values depict areas where concentrations were typically above the regional average, and negative values depict areas of lower concentrations.

The resulting contours are consistent with much of what has been presented above. This figure once again shows the greatest ozone exposure to the northwest of Las

Vegas, driven primarily by daytime upvalley and upslope winds. This plot however emphasizes to a greater extent the impact on the foothill locations in this area. In contrast, areas to the northeast of Las Vegas show only average concentrations, and the area around Searchlight is clearly upwind of the urban plume. Even without the Sunset Park data, the contours suggest the possibility of higher concentrations in the southwest portion of Las Vegas near McCarran airport. Finally, there is also some evidence of consistently higher concentrations in the area around Craig Ranch.

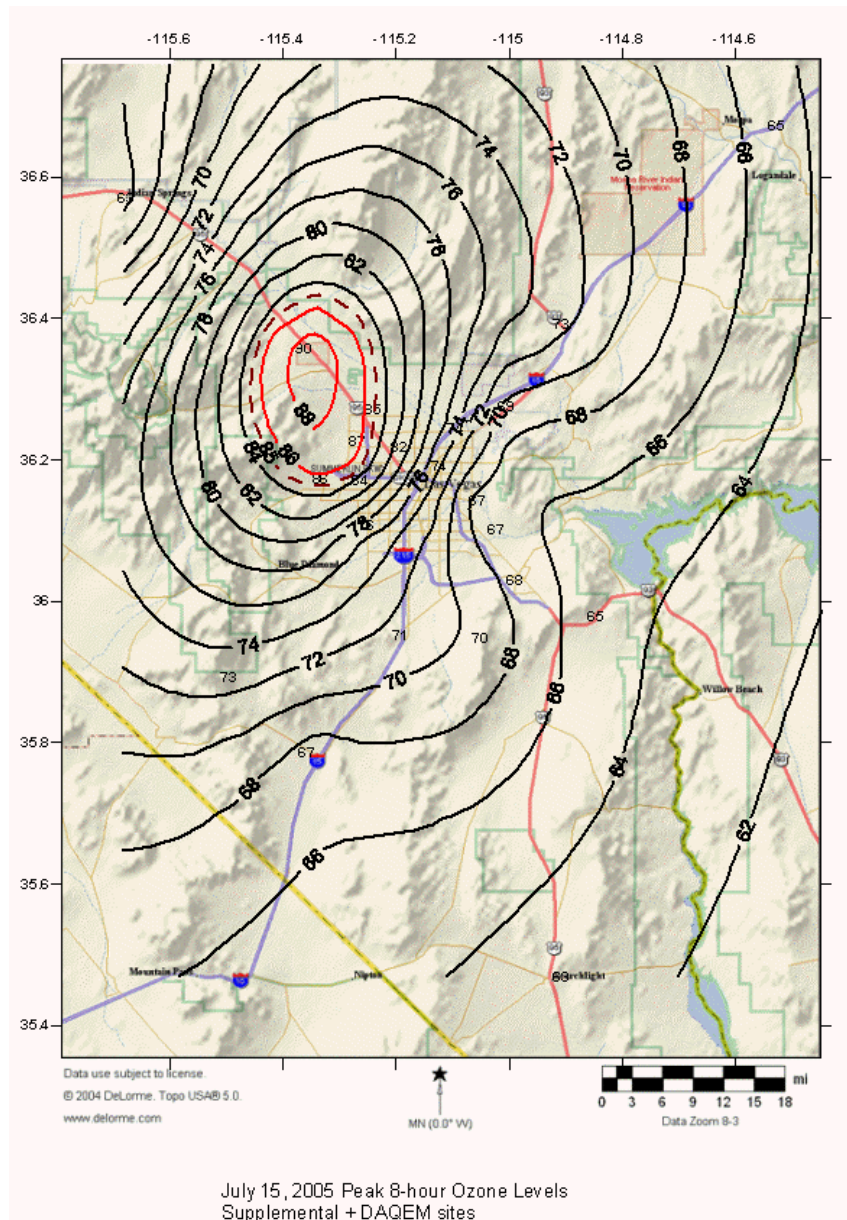

Figure 7-16. Maximum 8-hr Ozone Levels for July 15 at Both DAQEM and Supplemental Sites

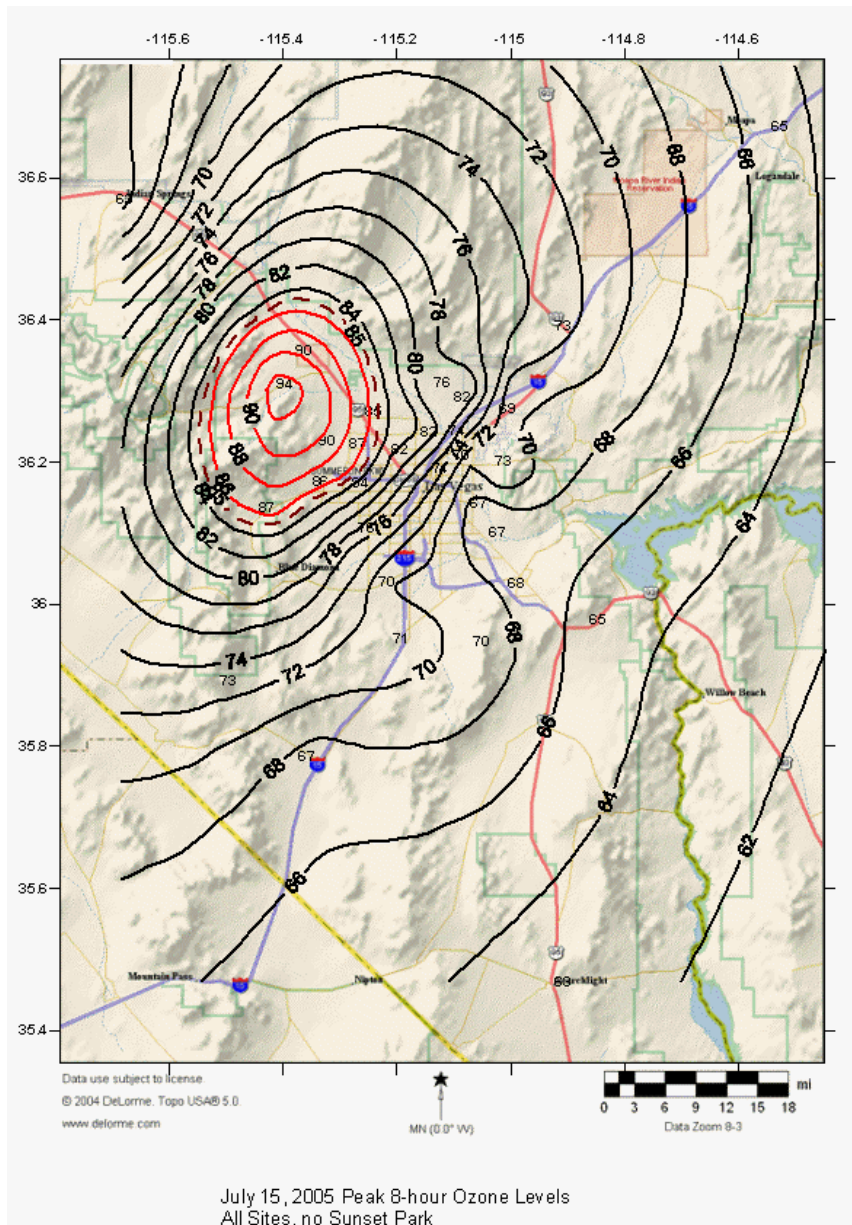

Figure 7-17. Maximum 8-hr Ozone Levels for July 15 at All CCROPS Sites Including Saturation Sites

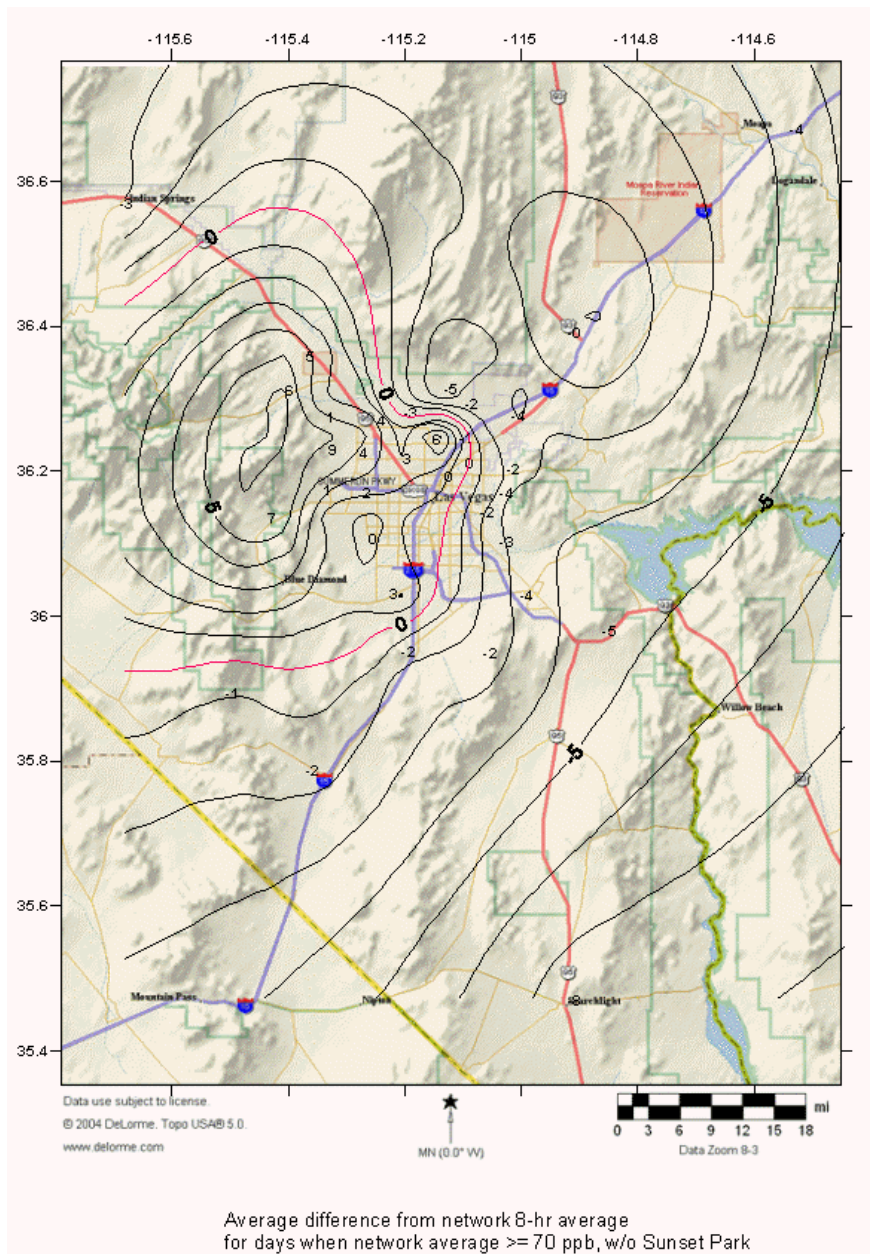

Figure 7-18. Composite Representation of Relative Ozone Concentration During IOPs

Jean Site

Another objective of the network evaluation was to determine if Jean is representative of the Las Vegas Valley upwind ozone levels. Air transported between the highly urbanized southern California and southern San Joaquin Valley would have a trajectory roughly over the Goodsprings Valley where Jean is located. Our approach was to site one of the supplemental ozone and meteorological stations at Sloan, a small rural community adjacent to I-15 at the southwest edge of the Las Vegas Valley. Sloan is between both valleys, approximately 15 miles northeast from the DAQEM site at Jean. Since the prevailing winds in west Clark County are southwest and Sloan is situated in the lowest gap in the terrain that defines the west side of the Valley, it was logical that

the air quality there would often be representative of the air flowing into the Valley. The site was situated on a hilltop approximately 200 m above the surrounding terrain to reduce the impact of I-15 traffic and nighttime surface deposition. As supposed, Sloan proved to be located directly in the gap where there is a major influx of air to the Las Vegas Valley. The observed winds at Sloan are depicted in the wind-rose diagram in **Figure 7-19**. As can be seen, winds are remarkably persistent from the southwest and very strong.

All indications from the 2005 measurements is that the site at Jean is situated well for measuring upwind/background under most meteorological circumstances. This is illustrated by the plot in **Figure 7-20** comparing the daily peak 8-hr ozone at Jean and Sloan. Ozone at the two sites compare as well as many collocated measurements and are within 2 percent of each other. Since there appears to be a well-defined pathway between Jean and Sloan, and ozone levels at the two sites are comparable, it follows that the ozone burden at Jean is representative of the inflow to the Las Vegas Valley.

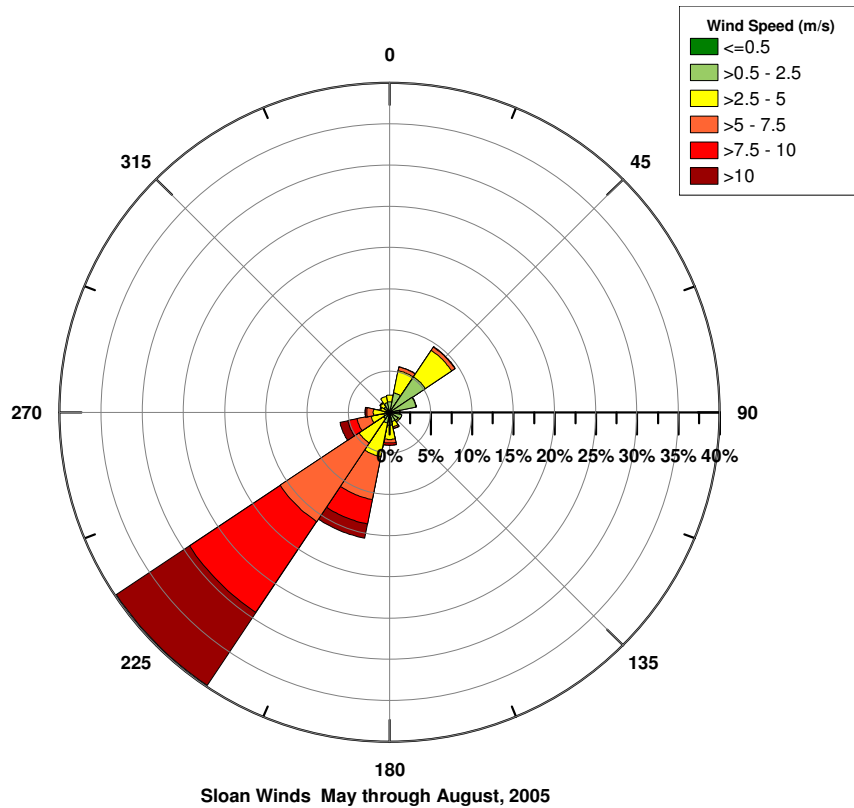

Figure 7-19. Wind Rose Diagram for Sloan

Ridgetop Sites

One of the questions addressed during CCROPS was the usefulness of ridgetop sampling in the Las Vegas area, with the specific goal of measuring ozone aloft, particularly during the night and morning hours. Figure 7-21 demonstrates how the

differences in siting influences the diurnal variations in ozone at five sites in the Las Vegas area:

- North Las Vegas (airport). This is a typical urban site, located in the middle of the Las Vegas Valley. Temporal patterns are classic for this type of site – a strong diurnal variation consisting of high afternoon peaks and the nearly total titration of ozone at night by urban emissions, particularly NO.
- Jean. As discussed above, this is a good example of a rural background site. Lacking are the afternoon peaks associated with a downwind urban site such as North Las Vegas. Nighttime ozone concentrations remain relatively high in this rural, upwind site, though the region is likely still influence by nocturnal inversions, which typically affect the lower 1000 m or so (see **Figure 7-22** for an example).
- Paiute. This site is representative of conditions downwind of urban activities and their associated emissions and subject to the aged urban plume. This site shows the same afternoon peaks as North Las Vegas. However, the nighttime concentrations are not nearly as low as those at North Las Vegas, due to the site's rural location, which is not impacted greatly by local emissions.

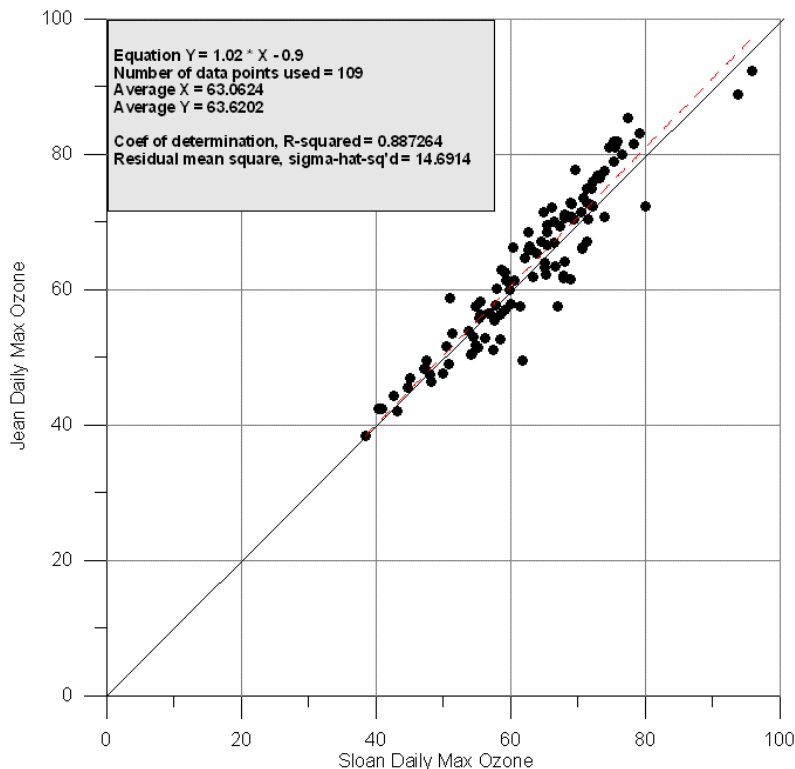

Figure 7-20. Comparison of Daily Maximum Ozone at Jean and Sloan

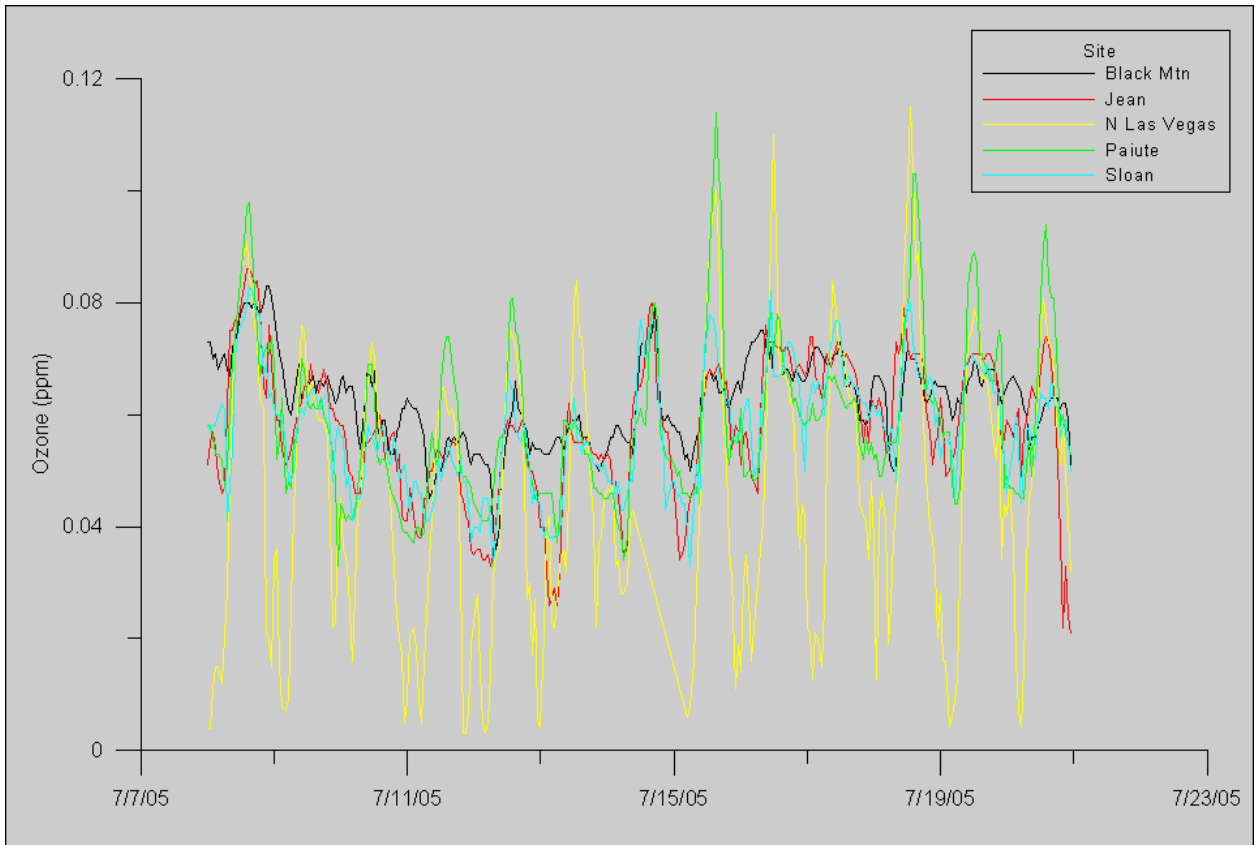

Figure 7-21. Time-Series Plot Showing Relationship Between Ridgetop and Valley Sites

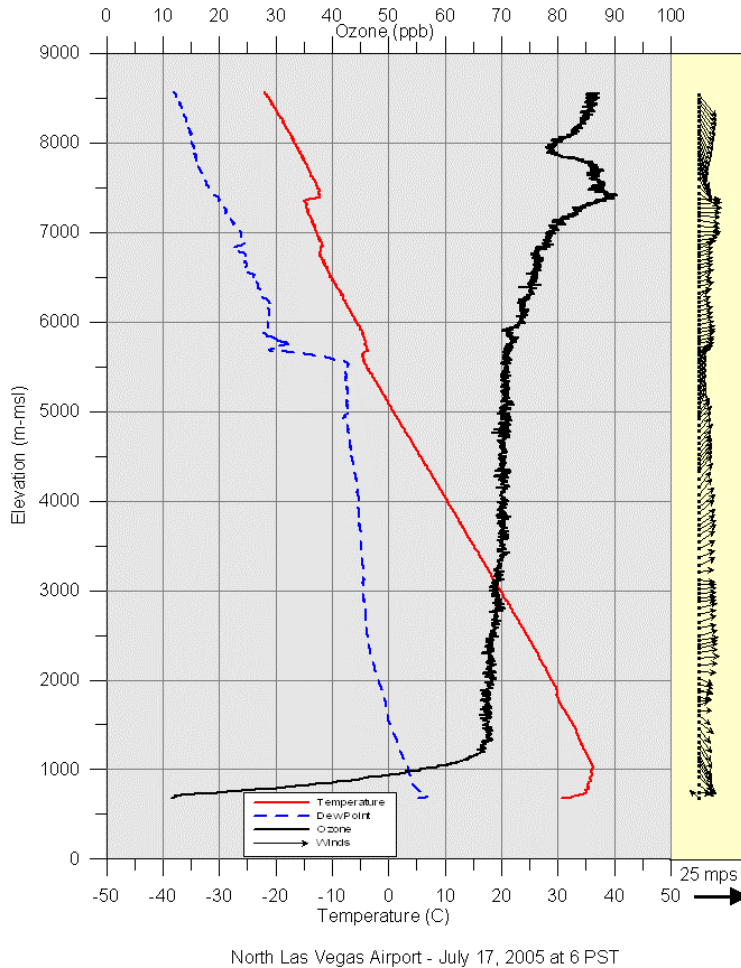

Figure 7-22. Example of Ozonesonde Data Showing Morning Inversion at 1000 m

- Sloan. The Sloan site was chosen as a location that would possibly experience relatively high nighttime concentrations due to elevated ozone layers not being subject to as much deposition and titration from surface effects. Moreover, Sloan is upwind of the Las Vegas Valley based on prevailing winds. The site is located about 200 meters above the general terrain at about 1000 meters-msl. Thus the site was likely still below the top of the nocturnal inversion, and some scavenging of ozone still occurred, similar to Jean. As noted above and in viewing Figures 7-20 and 7-21, ozone concentrations at Sloan and Jean are virtually the same.
- Black Mountain. Located above the typical top of the inversion layer at 1221 meters-msl and in a rural area, basically upwind of Las Vegas. Ozone at Black Mountain exhibits virtually no diurnal variation. Readings from this site may accurately provide a continuous record of regional background concentrations, and for the most part are unaffected by nocturnal inversions. Figure 7-21 shows several instances during the night when readings from Black Mountain are significantly higher than those from the valley floor sites under the inversion. These readings represent potential ozone that can be entrained to the surface during daytime convective mixing.

Ozonesondes were employed during the episode-mode monitoring periods of CCROPS. A possible alternative to expensive ozonesondes for determining ozone concentrations aloft is to maintain a ridgetop monitor such as the one at Black Mountain. **Figure 7-23** is a time series plot covering the period of the July IOP, during which several ozonesondes were released. Time-series plots of surface ozone concentrations from North Las Vegas, Black Mountain, and Lower Potosi are shown. Superimposed on these plots are readings from the ozonesonde measurements corresponding to each site's elevation. Note that North Las Vegas Airport was situated at 681 m-mls, Black Mountain at 1221 m-msl and Lower Potosi at 1885m-msl. The figure shows in general very good agreement between the ozonesonde data and the continuous analyzers, and is particularly good at representing ozone concentrations aloft during the morning hours.

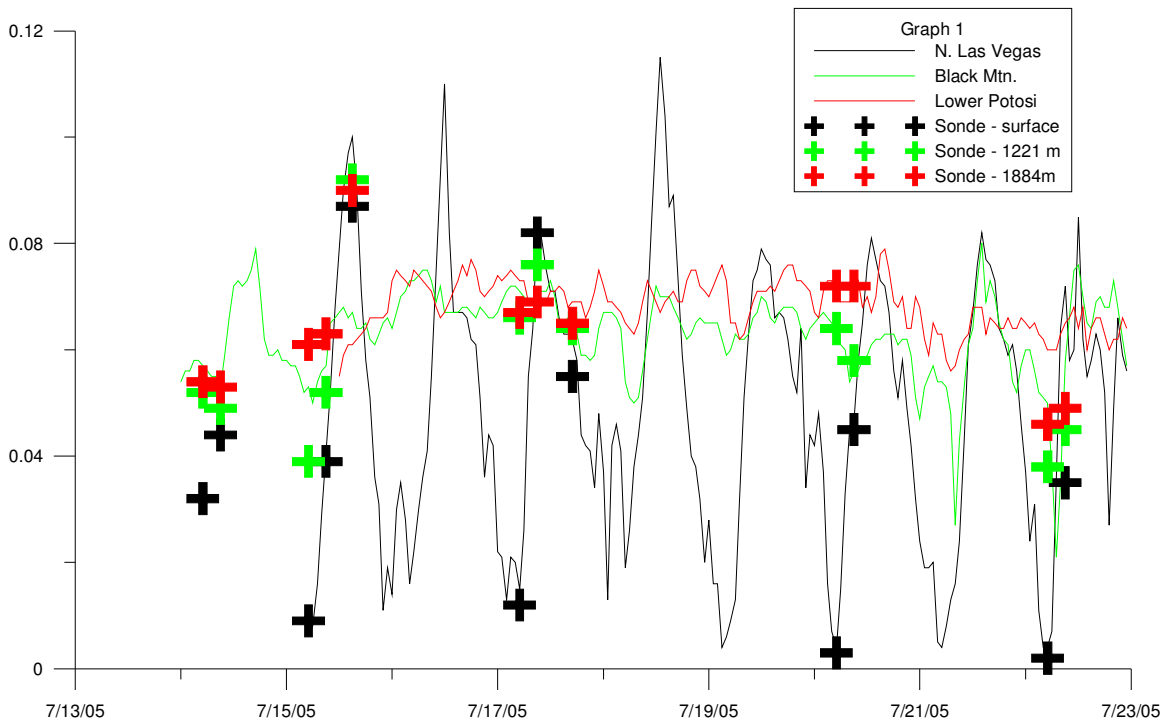

Figure 7-23. Ozone at Ridgetop Sites Compared with NLV Ozonesonde

Based on the above, the following changes are recommended to the monitoring network:

- The Ozone Characterization Study revealed that ozone data from City Center was being impacted by emissions from a major freeway. This was supported by the 2005 field study measurements. Indeed, the site does not currently meet EPA siting criteria for ozone due to its proximity to the freeway. No data from City Center were used for any of the above analysis, as they appear to be not representative of regional ozone concentrations, with unrepresentatively low daytime readings due to titration by NO from vehicles on the freeway. For these reasons, it is recommended that ozone monitoring be terminated at City Center. Data from the nearby JD Smith site appear to adequately represent this area.

- A permanent site at Paiute should be installed to ensure that peak ozone exposure in Clark County is measured.
- A permanent site at Indian Springs should be installed to further define the northwest extent of high ozone levels. Moreover, as growth and development continues to expand in the Valley, the ozone peak could conceivably shift further northwest.
- A temporary monitoring site at Sunset Park should be operated during the upcoming ozone season to further investigate the possibility of high ozone concentrations in that area.

In addition, the following monitoring should be considered:

- An additional ozone site in the foothills to the northwest of Las Vegas. The saturation network showed the urban ozone plume extending well into the foothill region. While the Lone Mountain site does a fairly good job of representing the area, an additional site may be warranted, especially as the area demographics changes. For example, housing developments are already extending to the Red Rock Canyon boundary. Kyle Canyon development and regions between will likely follow.
- Additional monitoring in the Craig Ranch area for similar reasons. Temporary monitoring should initially be considered to confirm the results obtained by the saturation network.
- To determine the importance of ozone aloft at night and early morning, for daily ozone forecasts, monitoring could be conducted at one of the two CCROPS ridgetop sites. Based on preliminary analyses, both the Black Mountain and Lower Potosi sites did a good job of producing measurements representative of ozone concentrations aloft. However, the Black Mountain site is considerably closer to the DAQEM office, and therefore easier to service.

7.7 Ozone Precursor Measurements

An integral part of the 2005 study was to measure ambient concentrations ozone precursors including volatile organic compounds (VOC) and oxides of nitrogen (NO_y). CE-CERT installed and operated NO_y measurements at two of the existing DAQEM sites for the duration of the 2005 field study. DRI established three VOC automated canister sampling sites that operated during episode-mode operations. Descriptions of the resulting measurements are given in this section.

7.7.1 NO_y

NO_y monitoring was conducted at two DAQEM sites. One was the JD Smith site in North Las Vegas. This site is impacted by emissions from the downtown portions of Las Vegas. The other site was Joe Neal which is generally downwind of the majority of pollution sources. Peak ozone levels in the Las Vegas Valley are often at or near the Joe Neal site.

Some general observations regarding the measurements follow:

Joe Neal Site

Table 7-4 shows the average concentrations for the nitrogenous species that were measured. PAN was not included since most of the values were below the 1 ppb detection limit. Nitric acid was also not included since it may be calculated from the differences between NO_y and NO_{y-} and since nitric acid was observed above the detection limit typically for a few hours in the afternoon, its contribution averaged over the day was small, typically a ppb, in comparison to the NO_y . At this site, which is not near local sources, the majority of the NO_y consists of NO_2 .

Figure 7-24 shows the concentrations of nitric acid plotted as two-minute averages for the month of August. Peak concentrations of 1-6 ppb are clearly observed each day in the afternoon. The plot shows some scatter because nitric acid is measured as a difference in concentration from samples that are slightly different in time; rapidly changing concentrations can therefore lead to sporadically high or low values.

Figure 7-25 shows the diurnal concentrations of nitric acid and ozone during the highest episode on August 12th. Both the nitric acid and ozone concentrations reach peak values near 13:00 hours PDT and a second higher peak at 16:00 hours. This is indicative of transport of these secondary pollutants from a source area.

Figure 7-26 is a graph of the NO_2 determined by the gas chromatograph (GC) compared with the NO_2 measured by the NO-NO_x chemiluminescent (CL) analyzer operated in the standard configuration by the Clark County Department of Air Quality and Environmental Management for the month of August. The overall trend line gives a slope of 0.86 indicating that the CL values are lower than GC, an unexpected result since the CL method should include other nitrogenous species as interferences. The plot shows, however, a divergence into two distinct lines at higher concentrations. The one with the higher slope is likely more indicative of aged photochemical nitrogenous species resulting in higher values for CL compared to GC.

JD Smith Site

Table 7-4 shows that the mean concentrations of nitrogenous species at the JD Smith site are significantly higher than those at the Joe Neal Site. The NO_y and NO_{y-} are nearly identical. On average, approximately half of the NO_y is NO_2 , a much smaller ratio than that found at the Joe Neal Site. This behavior is typical of a source-dominated site.

Figure 7-27 shows the concentrations of nitric acid plotted as two-minute averages for the month of August. Peak concentrations of nitric acid of 1-3 ppb are clearly observed each day in the afternoon. These are about half of that observed at the Joe Neal site, although, like at Joe Neal, the peak for the month is also on August 12th. **Figure 7-28** shows the diurnal concentrations of nitric acid and ozone during the highest episode on August 12th. Both the nitric acid and ozone concentrations reach peak values near 13 PDT and a second higher peak just before 16 PDT. This plot is very similar to that of the Joe Neal site, but the concentrations are approximately half as high. Although this is a source dominated site, this behavior is indicative of transport of these secondary pollutants from a source area.

Figure 7-29 is a graph of the NO_2 determined by the gas chromatograph (GC) compared with the NO_2 measured by the NO-NO_x chemiluminescent (CL) analyzer operated in the standard configuration by the Clark County Department of Air Quality and Environmental

Management for the month of August. The overall trend line gives a slope of 0.97 indicating little difference between the two measurement methods at this site. The plot does not show the divergence observed at the Joe Neal site.

Table 7-4. Mean Concentrations of Nitrogenous Species in 2005 at Joe Neal and JD Smith Air Quality Monitoring Sites

	NOy	NOy-	GCNO2
Joe Neal			
June	12.6	11.6	10.5
July	12.7	11.1	13.7
August	10.8	9.7	9.3
JD Smith			
June	33.3	33.1	13.3
July	38.9	38.8	19.9
August	33.5	33.5	16.5

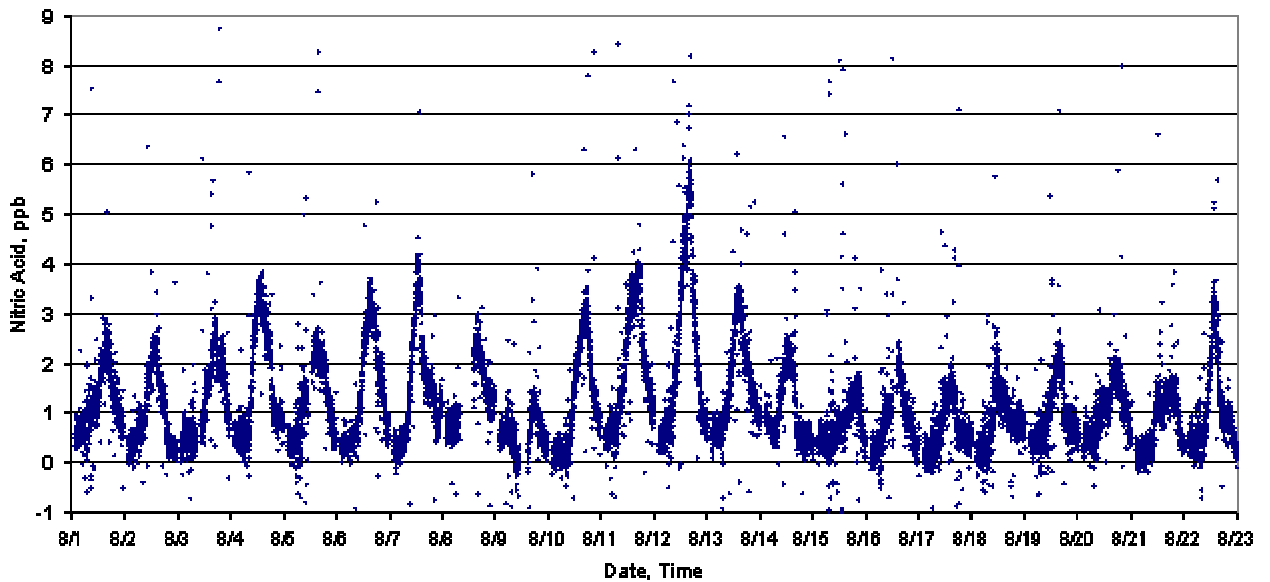

Figure 7-24. Plot of Nitric Acid for August 2005 at Joe Neal Site

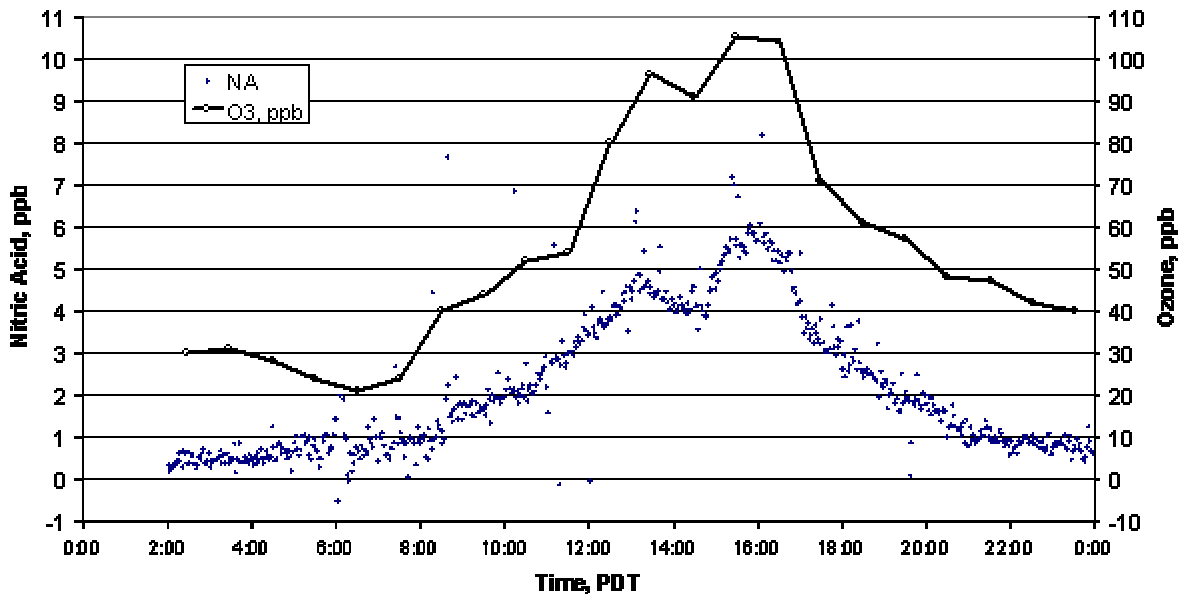

Figure 7-25. Plot of Nitric Acid and Ozone for August 12, 2005 at Joe Neal Site

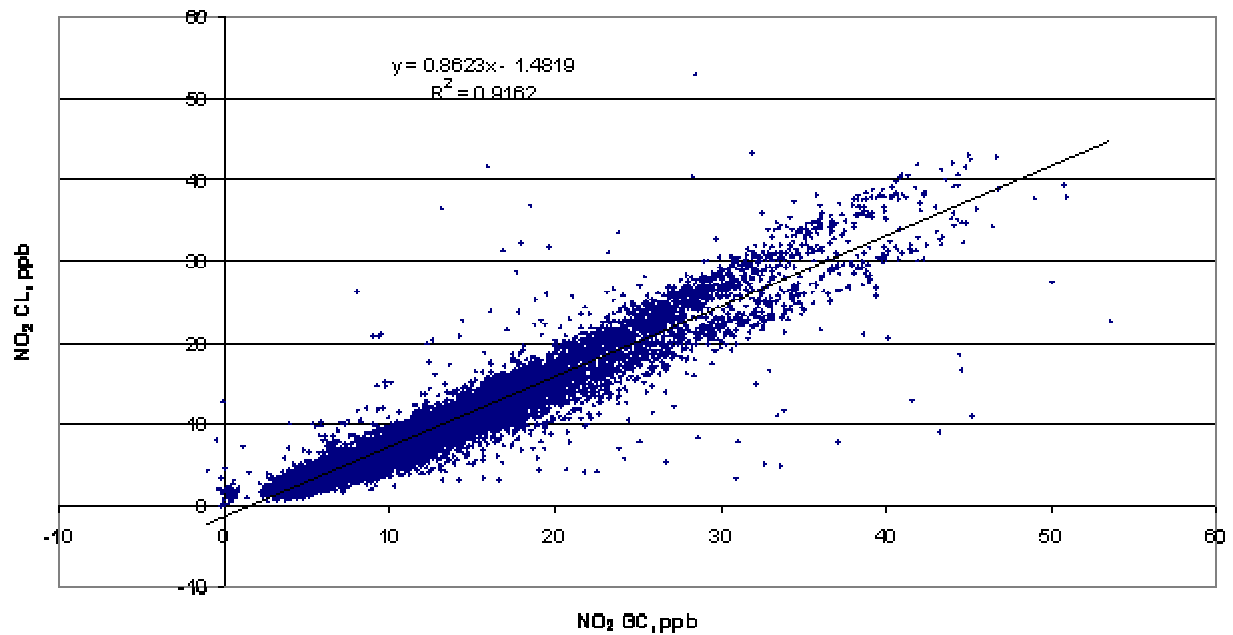

Figure 7-26. Comparison of NO₂ Determined by Chemiluminescence (CL) and Gas Chromatography (GC) at Joe Neal Site in August 2005

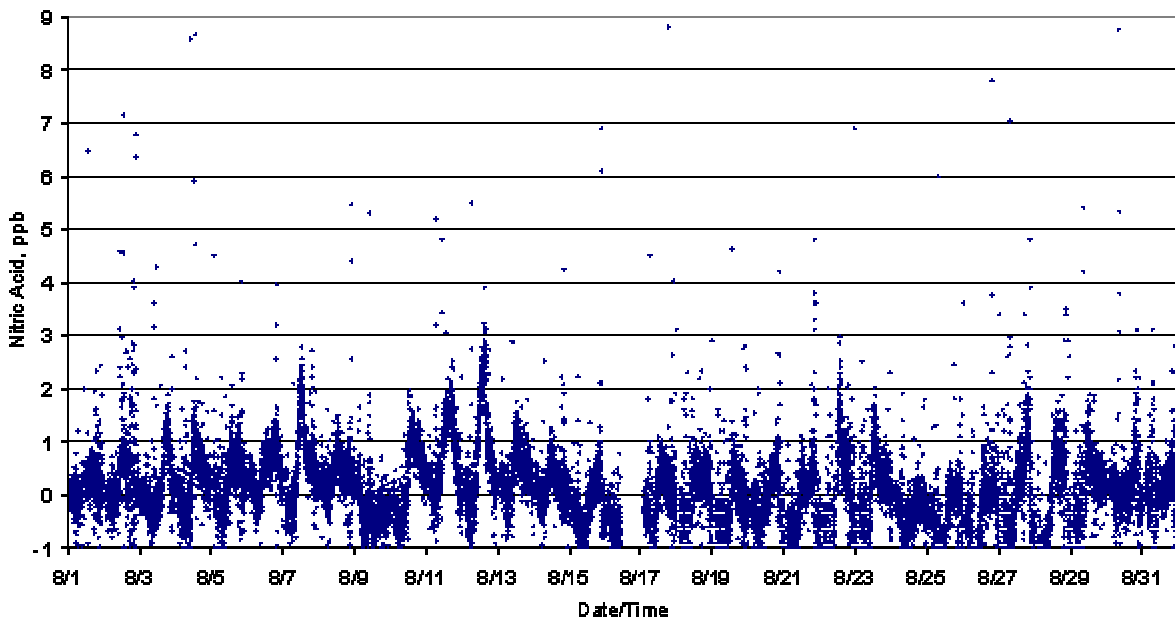

Figure 7-27. Plot of Nitric Acid for August 2005 at JD Smith Site

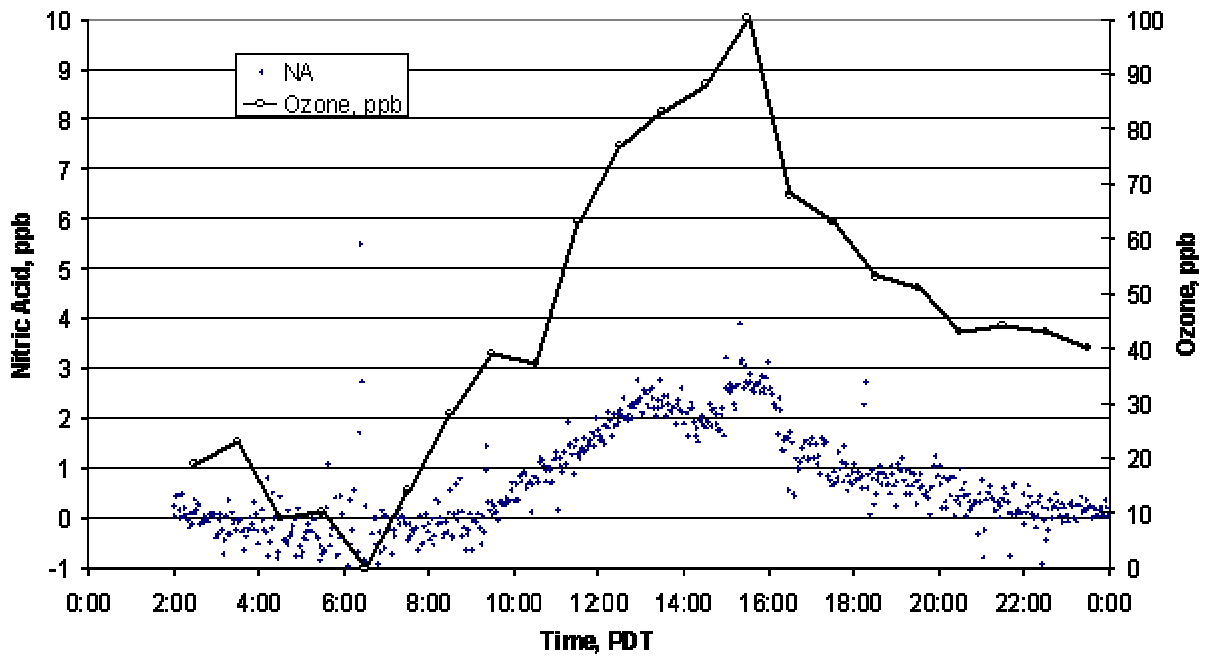

Figure 7-28. Plot of Nitric Acid and Ozone for August 12, 2005 at JD Smith Site

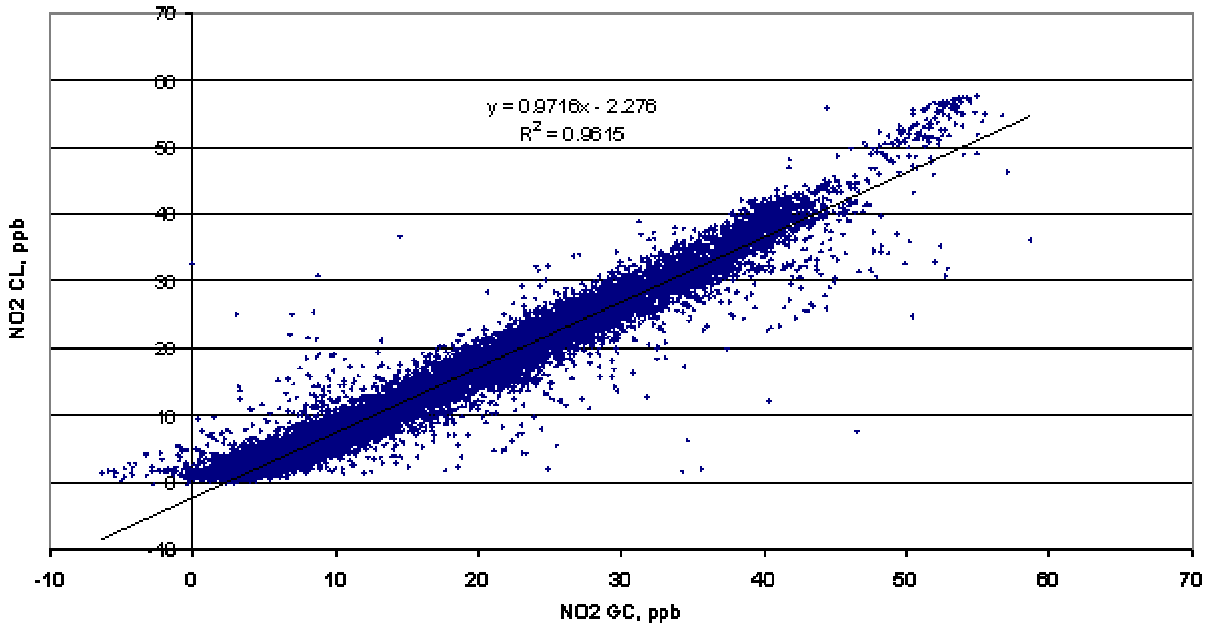

Figure 7-29. Comparison of NO₂ Determined by Chemiluminescence (CL) and Gas Chromatography (GC) at JD Smith Site in August 2005

The results show that nitric acid can be measured at both source and receptor sites in the Clark County metropolitan area. Typical concentrations are a few ppb in the afternoon, peaking concurrently with the ozone concentrations. Concentrations of nitric acid at the receptor site were typically twice those of the source-dominated site despite higher NO_y concentrations at the latter. At both site the contribution to the monthly mean NO_y was a ppb or less. Despite the potential positive interference of measuring NO₂ with chemiluminescent analyzers, there was little difference between measurements made using this technique and those made with high specificity using a gas chromatograph with luminol detection. During the entire study period PAN concentrations were all below the 1 ppb detection limit of the luminol-based gas chromatograph.

7.7.2 VOC Measurements

INSERT DRI SECTION

7.8 Balloon-Borne Measurements

Rawinsondes measure the vertical profiles of temperature, humidity and winds. When interfaced with the En-Sci monitors they measure ozone as well, hereafter referred to as an ozonesonde. During the CCROPS field study a total of 85 rawinsonde/ozonesonde observations were made from the North Las Vegas airport. Of those, 43 were ozonesondes. A complete list of the soundings taken at the North Las Vegas airport (NLV) is provided in **Table 7-5**. Table information includes the sounding day and time of balloon release, type of soundings (standard rawinsondes or Ozonesonde), and the range of data.

Table 7-5. Rawinsonde/Ozonesonde Schedule at NLV

Release			Sonde Type (S or O)	Data Range	
Date	Time	Sounding ID		Bottom Ht(m- agl)	Top Ht(m- agl)
23-May	530	NLV52306	S	590	6717
23-May	1650	NLV52316	S	786	6033
24-May	633	NLV52406	O	677	6228
24-May	1050	NLV52411	O	677	5993
24-May	1600	NLV52416	O	677	6674
25-May	530	NLV52506	S	677	6999
25-May	1600	NLV52516	S	677	6369
26-May	530	NLV52606	S	677	6518
26-May	1600	NLV52616	S	677	6189
27-May	610	NLV52706	O	677	7648
27-May	1030	NLV52711	O	677	6308
27-May	1735	NLV52716	O	677	3643
28-May	530	NLV52806	O	677	7128
28-May	1017	NLV52810	O	677	6848
28-May	1600	NLV52816	O	677	6972
29-May	542	NLV52906	S	677	6502
29-May	1721	NLV52917	S	677	6243
20-Jun	502	NLV62005	S	964	6509
20-Jun	1604	NLV62016	S	677	6091
21-Jun	504	NLV62105	S	677	6622
21-Jun	1613	NLV62116	S	677	6093
22-Jun	603	NLV62206	S	677	6881
22-Jun	1630	NLV62216	O	677	3721
23-Jun	600	NLV62306	O	677	6764
23-Jun	1015	NLV62310	O	677	6515
23-Jun	1608	NLV62316	O	677	6378
24-Jun	630	NLV62406	O	677	6955
24-Jun	1013	NLV62410	O	677	6773
24-Jun	1603	NLV62416	O	842	5916
25-Jun	555	NLV62506	O	677	6769
25-Jun	1554	NLV62516	S	677	6684
26-Jun	536	NLV62606	S	677	6597
26-Jun	1557	NLV62616	S	677	6416
27-Jun	530	NLV62706	S	677	6505
27-Jun	1558	NLV62716	S	677	6022
28-Jun	539	NLV62806	S	677	6603
28-Jun	1554	NLV62816	S	677	5995
29-Jun	525	NLV62906	S	677	6791
29-Jun	1624	NLV62916	O	677	7582
30-Jun	529	NLV63006	S	677	6726
30-Jun	1557	NLV63016	S	677	6069

Table 7-5. Rawinsonde/Ozonesonde Schedule at NLV (continued)

Release			Sonde Type (S or O)	Data Range	
Date	Time	Sounding ID		Bottom Ht(m- agl)	Top Ht(m- agl)
1-Jul	618	NLV70106	O	677	7262
1-Jul	1011	NLV70110	O	677	7434
1-Jul	1622	NLV70116	O	677	7111
2-Jul	603	NLV70206	O	677	7103
2-Jul	957	NLV70210	O	677	6765
2-Jul	1608	NLV70216	O	677	8218
12-Jul	529	NLV71206	S	677	7375
12-Jul	1555	NLV71216	S	677	1139
12-Jul	1630	NLV71217	S	677	8004
13-Jul	528	NLV71306	S	677	8044
13-Jul	1603	NLV71316	S	1326	7458
14-Jul	620	NLV71406	O	677	8150
14-Jul	1017	NLV71410	O	677	7339
14-Jul	1605	NLV71416	O	677	6696
15-Jul	627	NLV71506	O	677	9185
15-Jul	1024	NLV71510	O	677	7805
15-Jul	1701	NLV71516	O	677	7427
16-Jul	525	NLV71606	S	677	7909
16-Jul	1600	NLV71616	S	677	7007
17-Jul	558	NLV71706	O	677	8555
17-Jul	1010	NLV71710	O	677	8169
17-Jul	1854	NLV71718	O	677	8228
18-Jul	556	NLV71806	S	677	7932
18-Jul	1618	NLV71816	S	677	7198
19-Jul	543	NLV71906	S	677	7837
19-Jul	1618	NLV71916	S	677	8876
20-Jul	558	NLV72006	O	677	8241
20-Jul	1000	NLV72010	O	677	10333
20-Jul	1607	NLV72016	O	677	8008
21-Jul	530	NLV72106	S	677	8764
21-Jul	1559	NLV72116	S	677	7841
21-Aug	542	NLV82105	S	677	6207
21-Aug	1600	NLV82116	S	677	7035
22-Aug	634	NLV82206	O	677	8426
22-Aug	1002	NLV82210	O	677	6014
22-Aug	1633	NLV82216	S	677	6763
27-Aug	557	NLV82706	S	677	7169
27-Aug	1712	NLV82716	O	677	8043
28-Aug	648	NLV82806	S	677	7749
28-Aug	1007	NLV82810	O	677	6812
28-Aug	1659	NLV82816	O	677	7820
29-Aug	629	NLV82906	O	677	7703
29-Aug	1030	NLV82910	O	677	7689
29-Aug	1638	NLV82916	S	677	6144

Beginning in the early evening, as the ground surface cools, a surface based inversion develops. Typically this nocturnal boundary layer is decoupled from the air aloft which can cause complex ozone layering in the vertical and associated wind shears. An example of a well-developed boundary layer with both ozone concentration and wind shears is shown on **Figure 7-30**. Temperature, dew point temperature, ozone, and winds with height are shown. On July 1 at 06 PDT, a surface-based temperature inversion extended to about 1200m or about 500m above the ground. At the surface, ozone concentrations were about 25 ppb, which were the lowest concentrations measured on this sounding. A layer of 70-75 ppb ozone resides above the nocturnal inversion to ~ 4200m, capped by a stable layer characterized by an inversion associated with lower humidity and ozone.

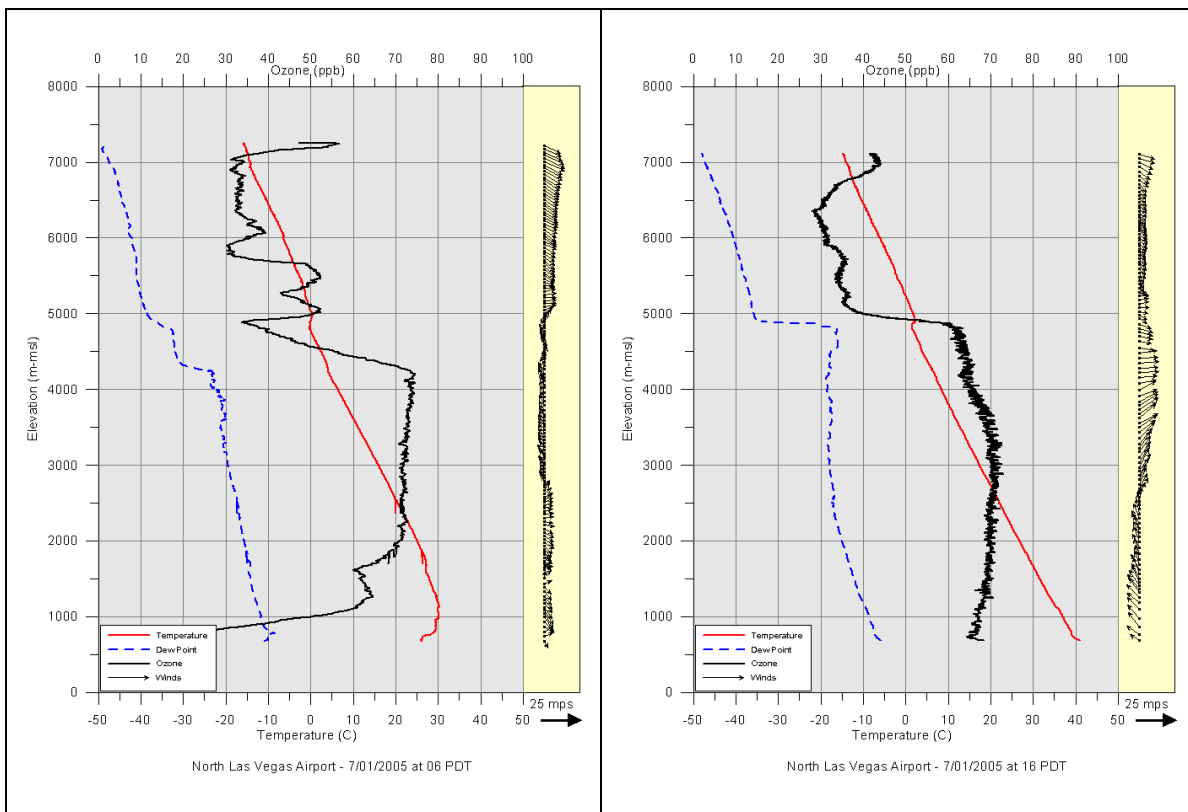

Figure 7-30. Ozone sondes Soundings at NLV on July 1, 2005

During the day, as the ground surface warms due to insolation, the boundary layer deepens and surface-emitted pollutants readily mix vertically. The afternoon sounding on July 1 is shown on right panel in Figure 7-31. Ozone is well-mixed and uniform in a layer from the ground to about 4900m, at which point a temperature inversion occurs. This scenario was repeated throughout the study. Mixing during the night and early morning hours was limited by a nocturnal inversion. Daytime mixing intensified throughout the late morning, peaking in the afternoon typically to more than 4000m above the ground.

With the exception of wildfire impacts, there has been initially little evidence of major interbasin transport during 2005. When atmospheric conditions were conducive to long-range transport from major source regions in California, heavily polluted air either had

not accumulated in those basins or wildfires were present, which in themselves produced high ozone levels aloft. However, the data should be examined more closely to determine the sources of ozone aloft that were observed.

The combination of vertical mixing and horizontal movement due local winds is commonly referred to as dispersion. Surface concentrations of pollutants are highly dependent upon dispersion conditions. Thus, from a modeling standpoint, mixing height and low-level winds are all-important. One objective of the study was to determine if the routinely taken sounding at Desert Rock (DRA), approximately 40 miles north of (downtown) Las Vegas, adequately measures dispersion conditions over the Las Vegas Valley. NOAA takes the DRA sounding twice daily on weekdays but not on weekends, which is a major shortcoming. The DRA site is located at 1009 m-msl, which is substantially higher than the Valley floor.

Comparisons of the data from the project site at NLV with those from the NOAA site at DRA reveal that the latter are of only limited value in determining low-level dispersion conditions critical for characterizing ozone. The sounding plots on **Figure 7-31** provide an example of critical differences. The soundings were made at approximately the same time on the afternoon of June 29, 2005. These data are very important as some of the highest ozone levels measured in the network occurred on this date.

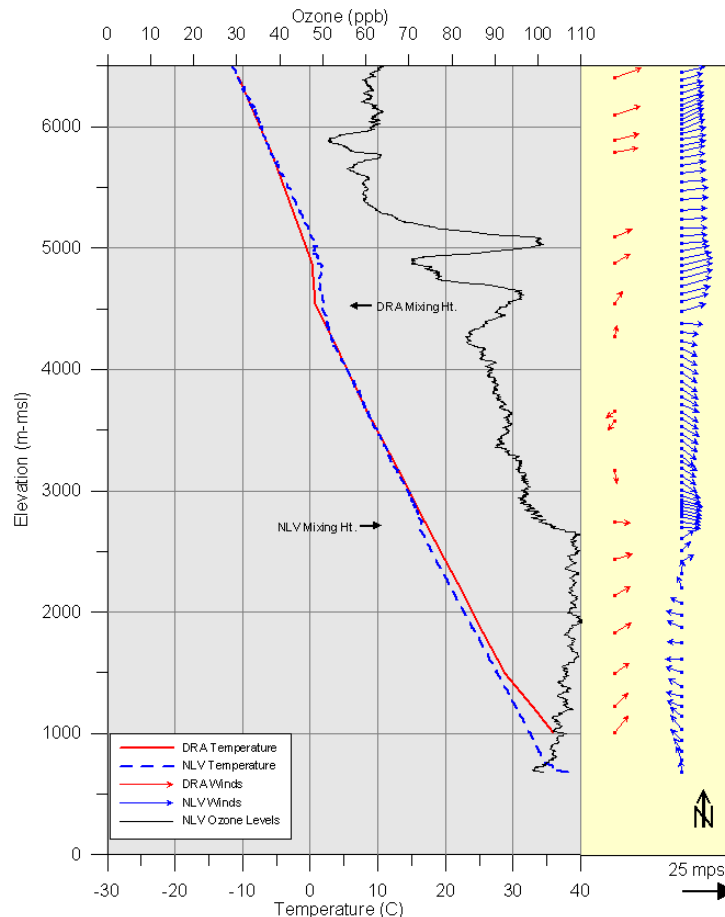

Figure 7-X Comparison of North Las Vegas Airport with Desert Rock
6/29/ 2005 at 16 PDT

Figure 7-31. Comparison of NLV and Desert Rock Soundings

The plot shows vertical temperature and wind structure from the two sites, as well as the ozone profile at NLV. A number of critical differences between soundings are evident. Note that ozone is well-mixed (uniform) in the 100-110 ppb range from the surface to 2700m-msl. This ozone layer is capped by a small but effective temperature inversion (dashed blue line) measured by the NLV sounding. The DRA temperature profile does not show this lower inversion. It would normally be inferred from the DRA temperature lapse-rate that pollutant mixing was active to the temperature inversion shown at 4500 m on both soundings. The reason the lower inversion was not captured in the DRA data may be from NOAA's standard procedure for minimizing the number of data points in a sounding for ease of transmitting. Soundings are summarized as 'significant levels' which reproduce the sounding within a stated accuracy that is not adequate for many air quality applications.

There are major differences in the winds as well. Wind directions within the boundary layer are almost 180 degrees different. Southeasterly to easterly winds were measured at NLV whereas southwesterly winds were measured at DRA. Its noteworthy that both soundings show decoupling based on wind shears at about 2700m-msl that corresponds to the boundary-layer depth indicated by temperature and ozone profiles at NLV. Winds at NLV are generally westerly above the boundary layer. The DRA soundings measured light and variable winds from about 3000m to 4300m-msl before becoming comparable to NLV (westerly) above.

In summary, the DRA sounding does not capture the critical lower-level winds and stability over the Las Vegas Valley, particularly at night and in the late morning, due to being situated on higher terrain. On occasions, such as the example on June 29, the critical features that influence dispersion are not characterized at all by the DRA observations.

7.9 Aircraft Measurements

Aircraft measurements were made using two airborne platforms. The primary platform was the glider with an additional instrument package added later in the program to the aircraft used to tow the glider to altitude. The glider was used to document the profile of ozone upwind of the Las Vegas Valley and identify any transported ozone from air basins upwind of the Clark County region. The tow aircraft was then used to document the profiles of ozone around the boundaries of the Valley and assess the contribution of ozone from the Las Vegas urban area.

Key to understanding and interpreting the data is assuring the quality of the data collected is understood. As the application of this sampling technique is relatively new, there were several quality control measures implemented and evaluations performed to assure the quality of the data. **Figure 7-32** shows the results of a parallel flight with both the glider and tow aircraft sampling systems. The purpose of the comparison was to determine the equivalency of the two sampling packages in measuring the same air mass. Additionally the tow package was audited using a certified ozone transfer standard with the results of the audit showing excellent agreement with the transfer standard. **Figure 7-33** shows the results.

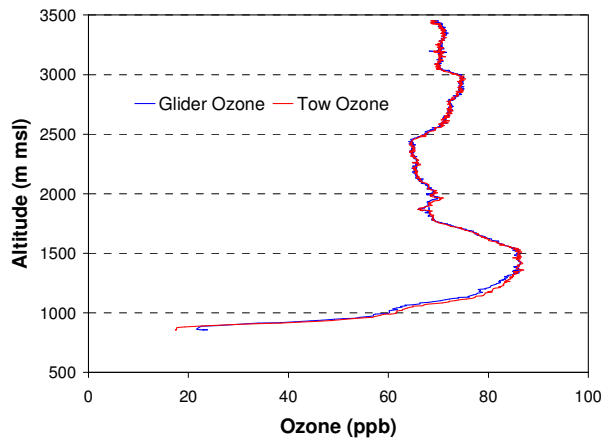

Figure 7-32. Results of Comparison Flight Between Glider and Tow Ozone Samplers

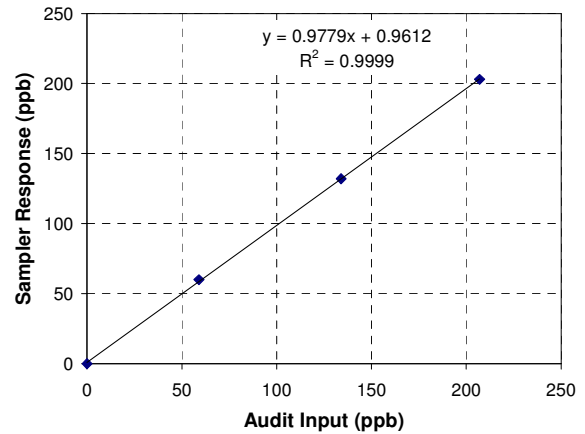

Figure 7-33. Results of Audit of Tow Aircraft Sampler

Some notable events were documented by both the glider and tow aircraft. These events are described below.

On July 2, 2005 the meteorology of the region was set for a transport event from the southwest with the synoptic flow providing the needed transport. Fires that were upwind of the region on previous days that had affected the air quality of the Clark County area, had been extinguished. On July 1 there were exceedances observed in both the San Joaquin Valley and South Coast Air Basins, as shown in **Figures 7-34** and **7-35**. Figure 7-35 shows the peak 24-hr AQI for July 1 and Figure 7-36 shows the peak hourly average ozone concentration. It should be noted that there is a gap in the measurement network in California, upwind of the Clark County region and this probably accounts for why lower values immediately upwind of Nevada are shown. **Figures 7-36** and **7-37** show the July 2nd values for the maximum AQI and 1-hr ozone concentrations, respectively with the exceedance noted in the vicinity of the Jean site on the AQI map.

Further supporting the transport scenario are the data from the glider soundings on the morning of July 2. **Figure 7-38** shows a time series of four soundings performed on July 2, with the glider documenting the presence of ozone aloft in the early morning and the subsequent mixing of the ozone to the surface by as early as 0730 PDT. By the time of the 1040 PDT sounding, a layer of ozone over 80 ppb was observed from the surface to over 2000 meters, the height of the mixed layer. Subsequently, exceedances of the 8-hr ozone standard were observed at the Jean site and at two of the project supplemental ozone stations.

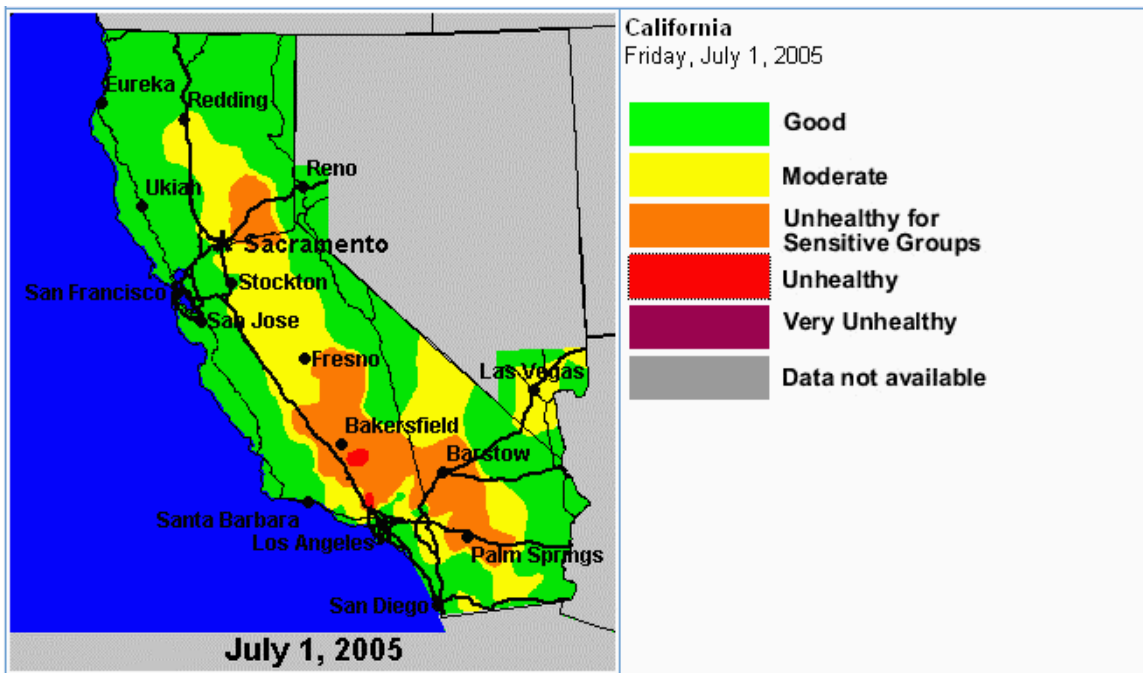

Figure 7-34. Maximum AQI for July 1, 2005

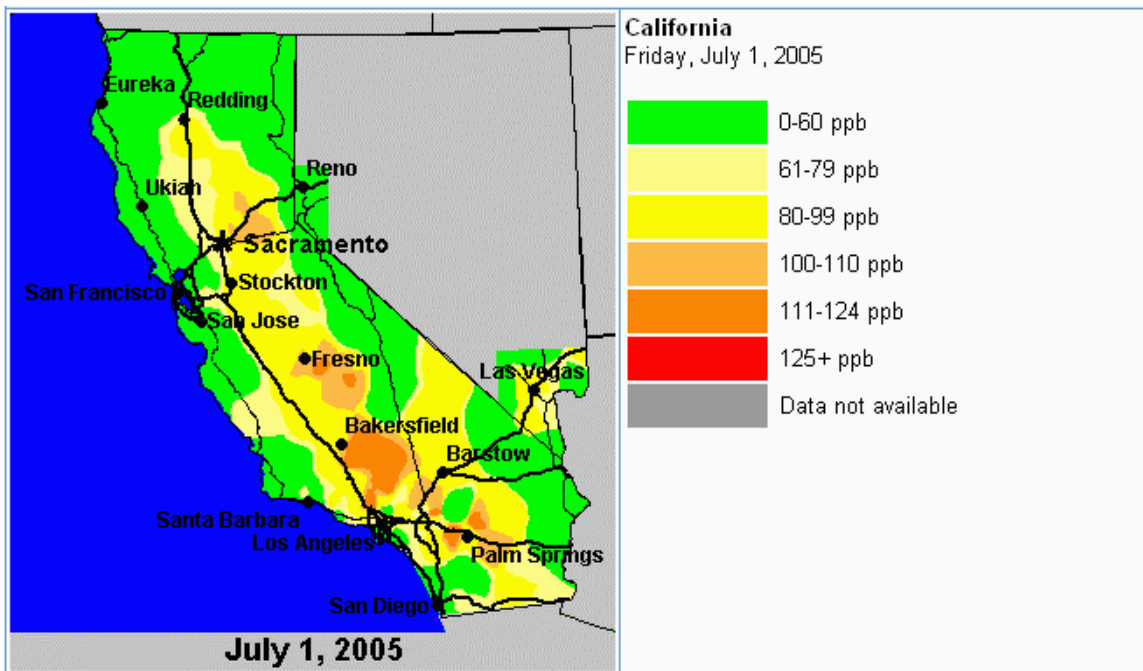

Figure 7-35. Maximum 1-Hr Ozone Concentrations for July 1, 2005

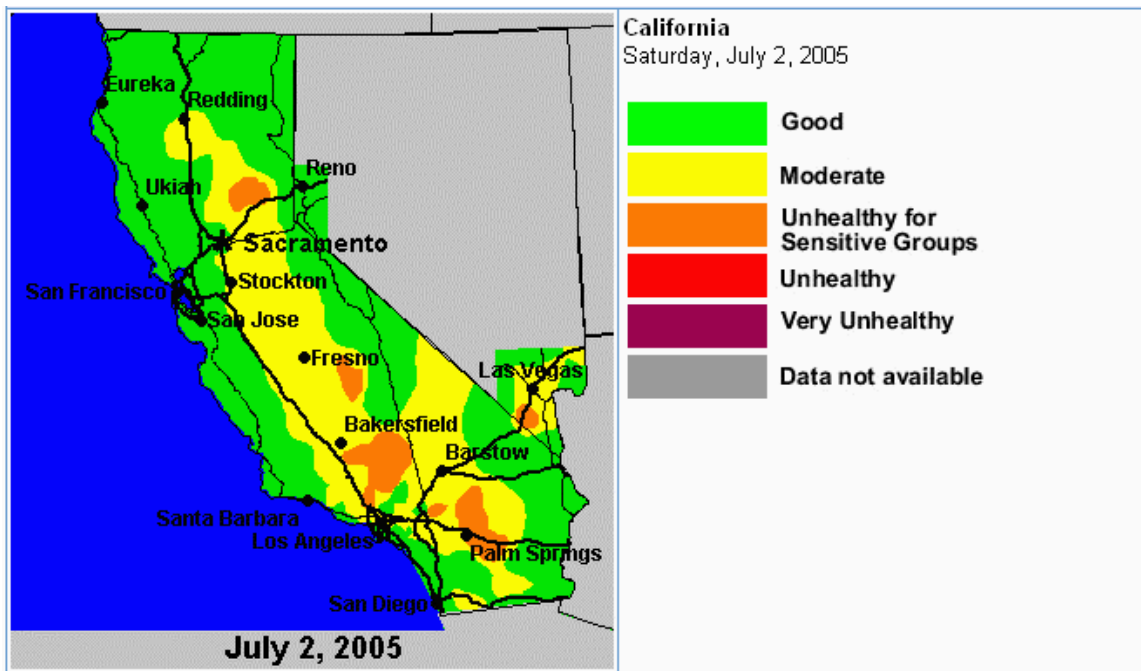

Figure 7-36. Maximum AQI for July 2, 2005, the Day of the Exceedance at Jean

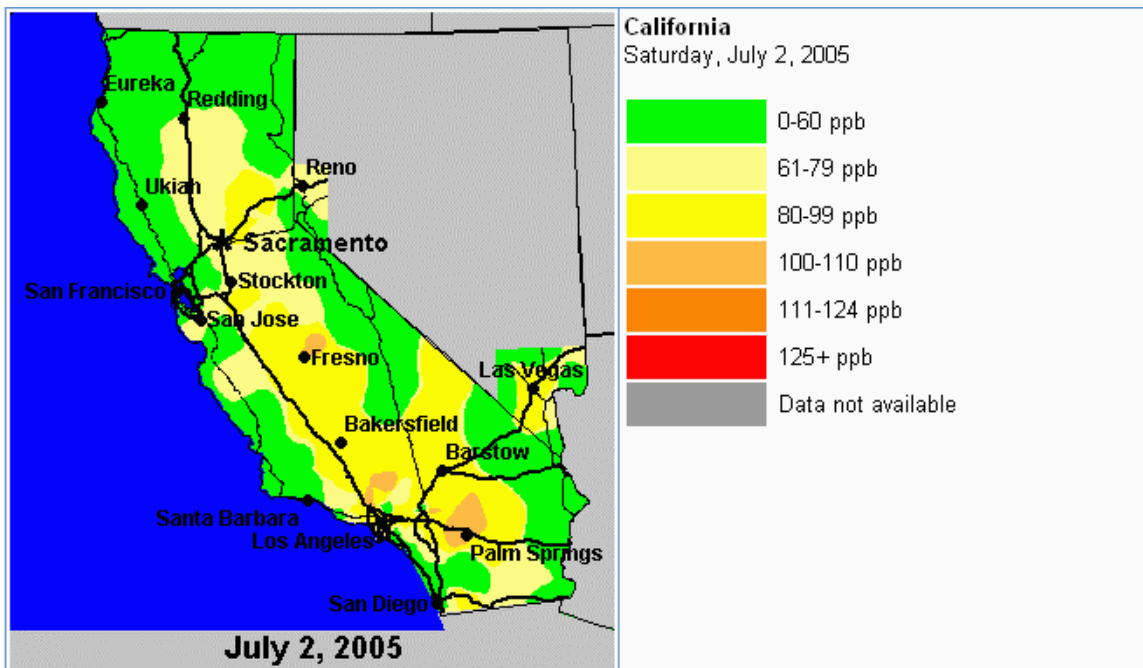

Figure 7-37. Maximum 1-Hr Ozone Concentrations for July 2, 2005

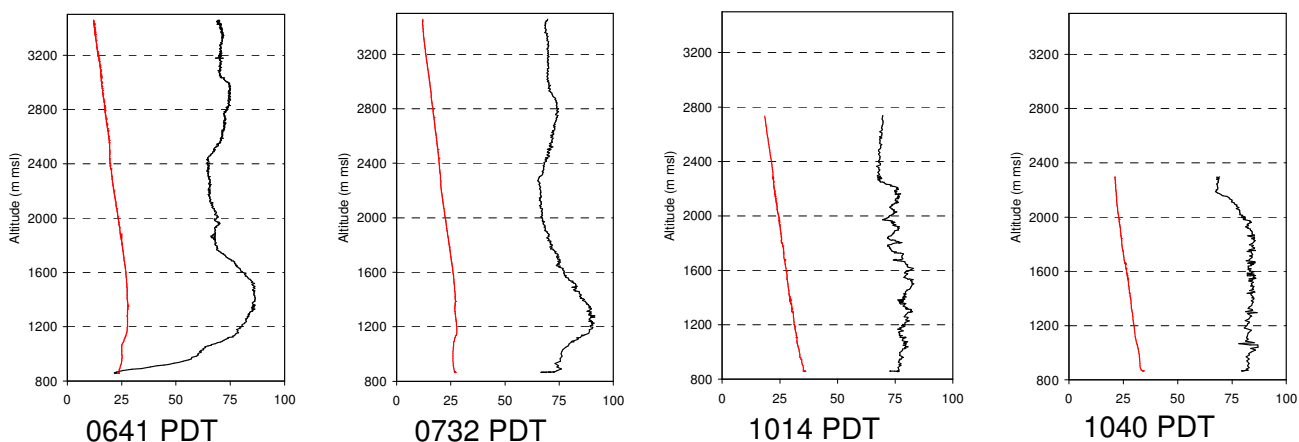

Figure 7-38. Four Soundings Showing the Progression of the Mixing of Ozone to the Surface. The red line is the temperature and black is ozone.

The primary goal of the sampling missions from the tow aircraft was to gain a better understanding of the spatial distribution of ozone throughout the Las Vegas Valley during transport scenarios and to assess the contribution of the urban area to the observed downwind ozone concentrations. To this end, the flight paths typically originated in the southwest, around the Jean airport and a box pattern was flown to the east, north, west and finally back to the south. This provided a traverse through the upwind and downwind regions from the urban center in Las Vegas. **Figures 7-39** through **7-43** show the afternoon traverse patterns from each of the flights. These patterns were flown from about 15 to 17 PDT, the period of the anticipated maximum 1-hour ozone concentrations, on each of the days. From the five flights that were conducted, and the differences observed between the upwind and downwind regions, the contribution of the urban area to the downwind concentrations during these flight days was estimated to be about 20 to 30 ppb. While none of the flight days occurred on exceedance days, the fact that ozone concentrations upwind of the Las Vegas Valley during transport events can be upwards of 80 ppb or more, indicates that this urban contribution to the air mass could provide the needed additional ozone to create exceedances of the NAAQS.

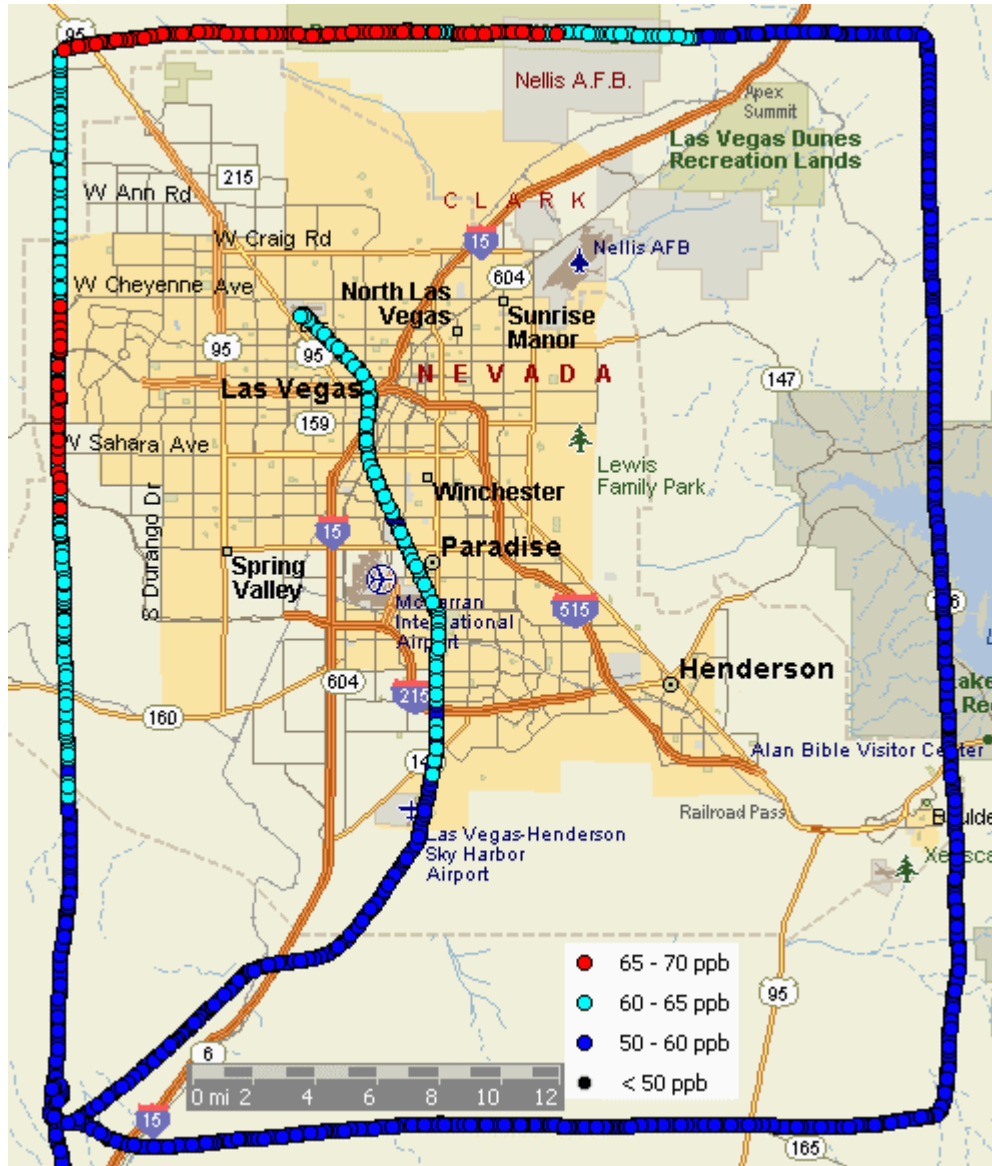

Figure 7-39. Aircraft Flight Observations of Ozone on August 21

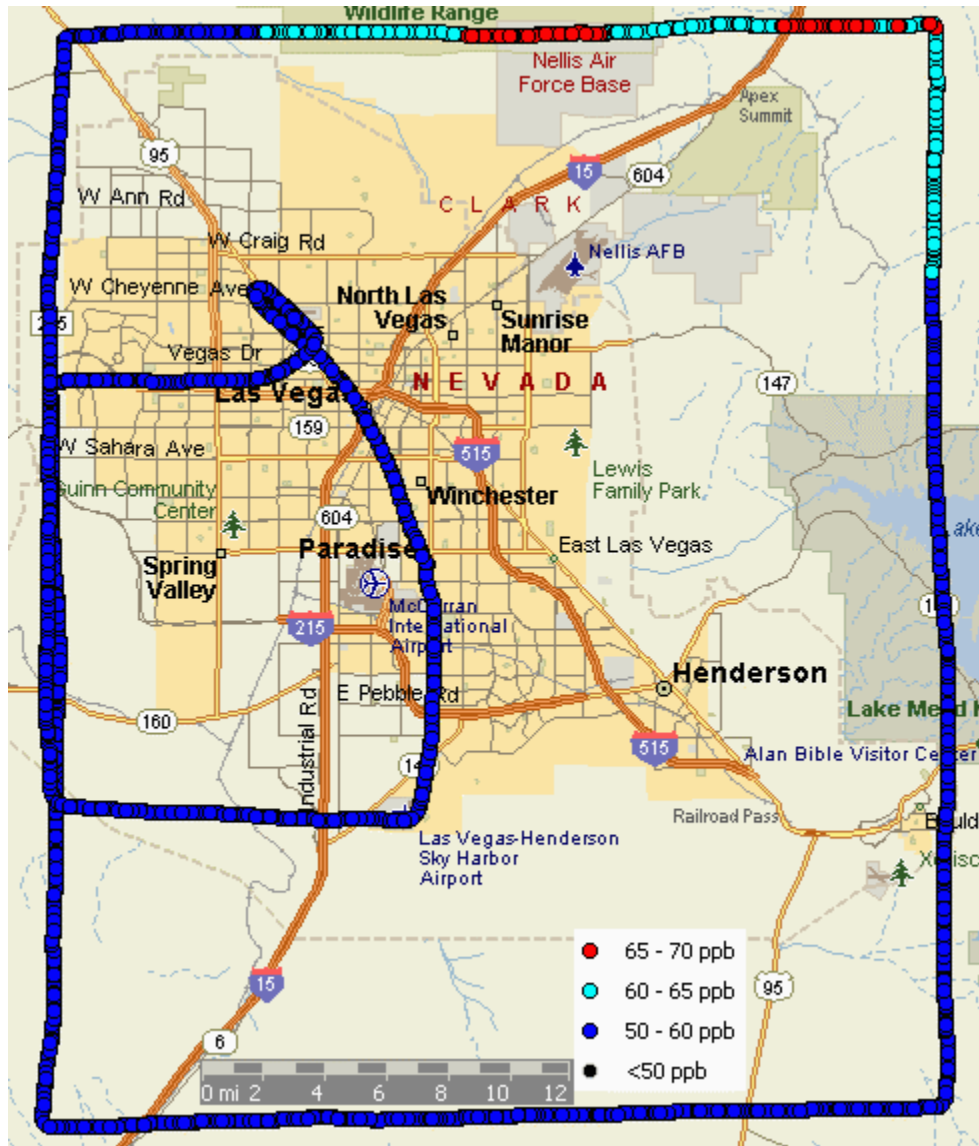

Figure 7-40. Aircraft Flight Observations of Ozone on August 22

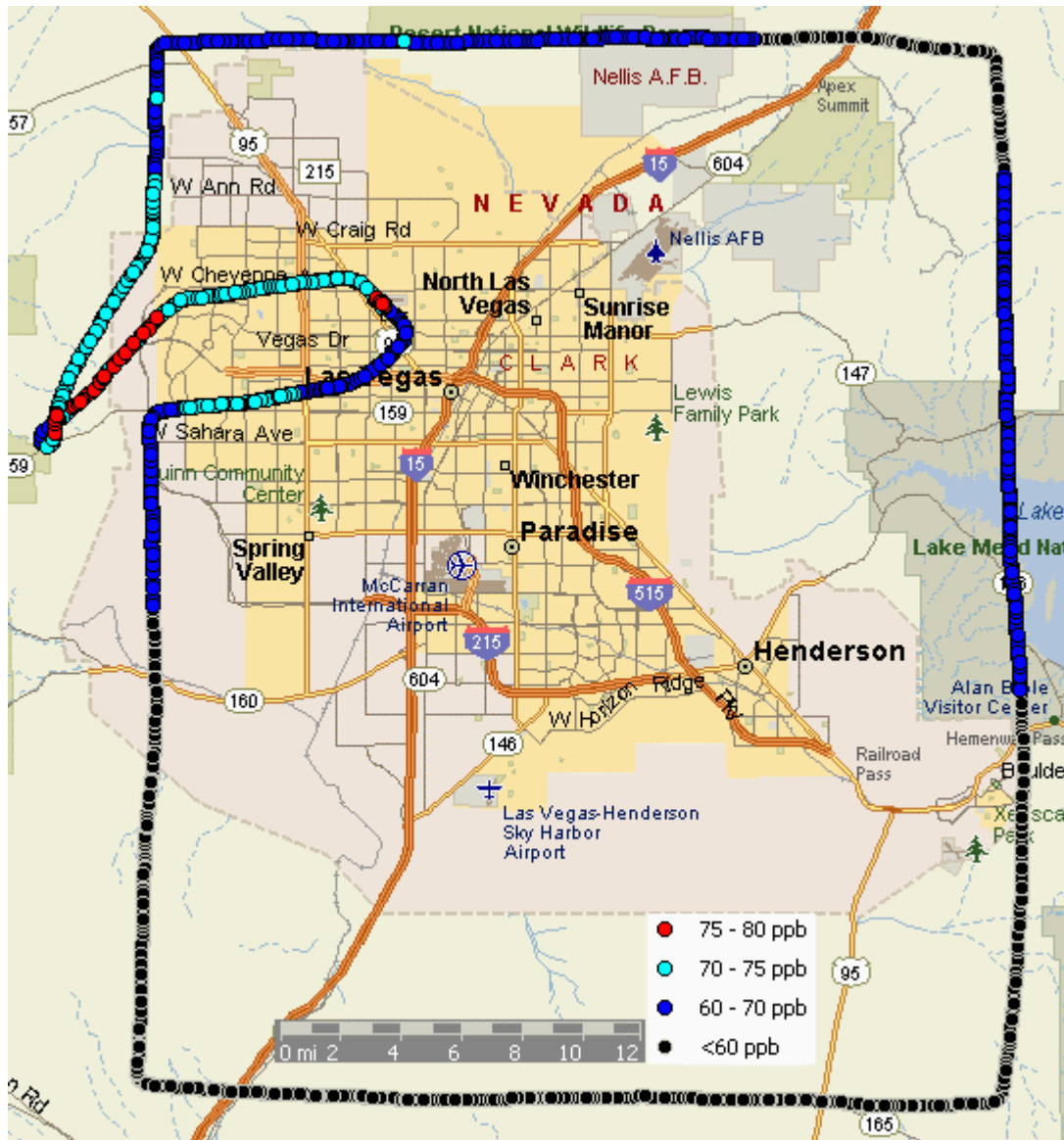

Figure 7-41. Aircraft Flight Observations of Ozone on August 27

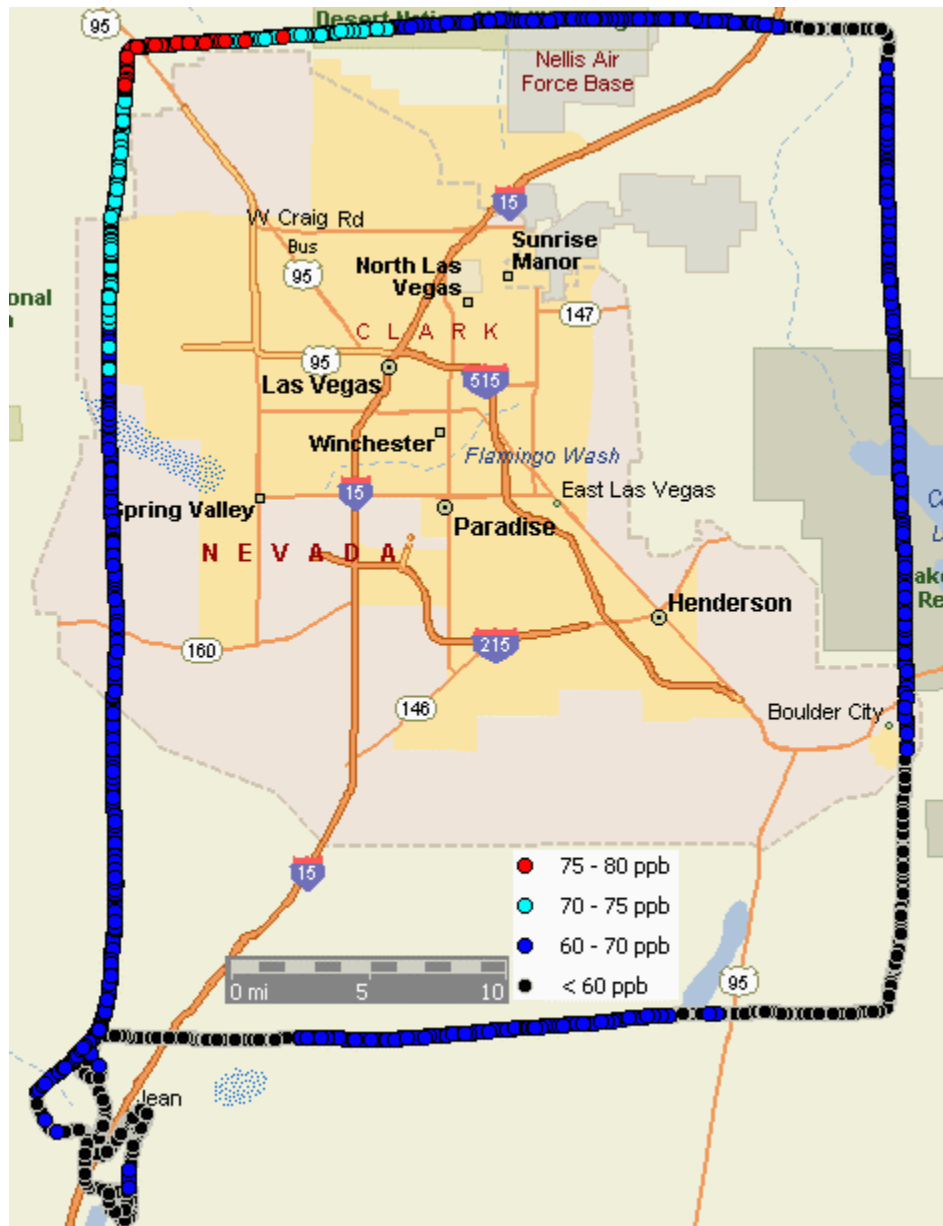

Figure 7-42. Aircraft Flight Observations of Ozone on August 28



Figure 7-43. Aircraft Flight Observations of Ozone on August 29

8. RECOMMENDATIONS

8.1 Recommended Monitoring Network Changes and Enhancements

On the basis of the existing and enhanced measurement network data collected during the 2005 field study, we have the following recommended monitoring network changes and enhancements:

- The Ozone Characterization Study revealed that ozone data from City Center was being impacted by emissions from an adjacent major highway. This was supported by the 2005 field study measurements. Indeed, the site does not currently meet EPA siting criteria for ozone due to its proximity to the highway. No data from City Center were used for any of the above analyses, as it appears to be not representative of regional ozone concentrations, with unrepresentatively low daytime readings due to titration by NO from vehicles on the freeway. For these reasons, it is recommended that ozone monitoring be terminated at City Center as it does not provide useful information regarding community health impacts. Data from the nearby JD Smith site appear to adequately represent this area.
- A permanent site at Paiute should be installed to ensure that peak ozone exposure in Clark County is measured.
- A permanent site at Indian Springs should be installed to further define the northwest extent of high ozone levels. Moreover, as growth and development continues to expand in the Valley, the ozone peak could conceivably shift further northwest.
- A temporary monitoring site at Sunset Park should be operated during the upcoming ozone season to further investigate the possibility of high ozone concentrations in that area.

In addition, the following monitoring should be considered:

- An additional ozone site in the foothills to the northwest of Las Vegas. The saturation network showed the urban ozone plume extending well into the foothill region. While the Lone Mountain site does a fairly good job of representing the area, an additional site may be warranted, especially as the area demographics changes. For example, housing developments are already extending to the Red Rock Canyon boundary. Kyle Canyon development and regions between will likely follow.
- Additional monitoring in the Craig Ranch area for similar reasons. Temporary monitoring should initially be considered to confirm the results obtained by the saturation network.
- To determine the importance of ozone aloft at night and early morning, and to aid in the daily ozone forecasts, monitoring could be conducted at one of the two CCROPS ridgetop sites. Based on preliminary analyses, both the Black Mountain and Lower Potosi sites did a good job of producing measurements

representative of ozone concentrations aloft. However, the Black Mountain site is considerably closer to the DAQEM offices, and would therefore be easier to service.

8.2 Recommended Additional Analyses

To further enhance the understanding of the ozone issues we recommend the following additional analyses of the data collected during the 2005 study:

- Select periods from the 2005 field study for detailed analyses and as candidates for DAQEM's numerical modeling based on 1) the quality and extent of measured data, 2) initial indications of the contributions from interbasin transport and/or local sources, and 3) representativeness. Detailed descriptive analyses should be performed of the 3-dimensional wind field using all sonde, sodar, and profiler measurements. The growth and decay of the surface boundary layer evaluated, and the characteristics of ozone and precursors both at the surface and aloft should be determined. This initial analysis suggests that the July 2 exceedance was the best candidate for overwhelming transport being the major contributor, and the July 14-18th period the best candidate for an exceedance primarily due to local sources. There were other episodes with greater exceedances but other factors such as wildfires would involve more complex emissions inventories and chemical processes.
- From the periods selected for detailed analyses and modeling, determine what features are critical to ozone processes. Compare these features with MM5 and ozone model outputs.
- Examine the hourly timing of peak ozone within the extended network. Characterize with respect to the 'conceptual model' developed from the detailed episode analysis.
- Using the entire data set, including aircraft measurements, quantify the contribution by the Las Vegas urban area to ozone concentrations under different meteorological scenarios.
- Integrate the ozone, VOC and NO_y data to determine extent of reaction and what information can be extracted regarding major sources.
- Examine the meteorology and air quality measurements at locations such as Moapa, Meadview, Mesquite, and western Utah for downwind impacts.
- Examine more in detail interbasin transport routes (e.g., Coachella Valley in the south and Antelope Valley in the north of the SoCAB, and Tehachapi Pass for San Joaquin Valley).
- Investigate in greater detail the effect that wildfires have on ozone formation. Determine the extent of the smoke plume using existing PM and NO_y data.
- Update and refine the existing CART model and forecasting protocol.

Clark County Regional Ozone & Precursor Study
APPENDICES TO:
“DRAFT” FINAL REPORT (P.O. 225900)

Prepared for:

Mr. William Cates
Clark County



Department of Air Quality & Environmental Management
500 South Grand Central Parkway
Las Vegas, NV 89106

Prepared by:

David Bush
Robert Baxter
William Knuth
Don Lehrman
Paul Fransioli
David Yoho



Dr. Wendy Goliff
Desert Research Institute
2215 Parkway
Reno, NV 89512

Dr. Dennis Fitz
CE-CERT
University of California, Riverside
1084 Columbia Ave.
Riverside, CA 92507

March 9, 2006

APPENDIX A:

Metafiles

To be provided in Final Report

APPENDIX B:

Surface Ozone Isopleths, Rawinsonde/Ozonesonde Plots, Trajectory Maps

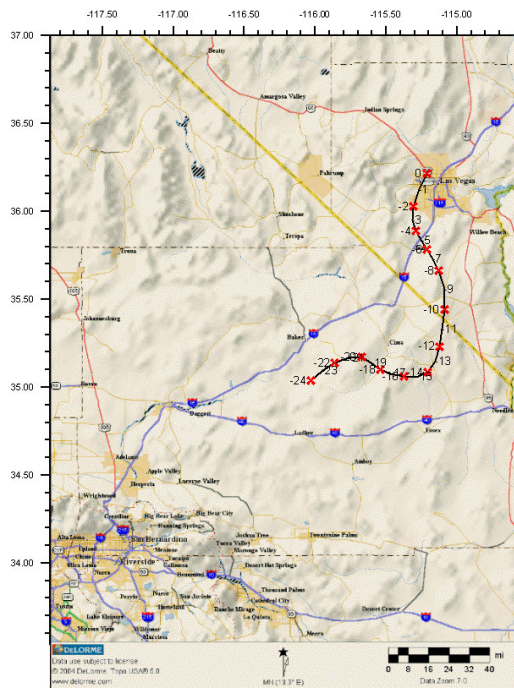
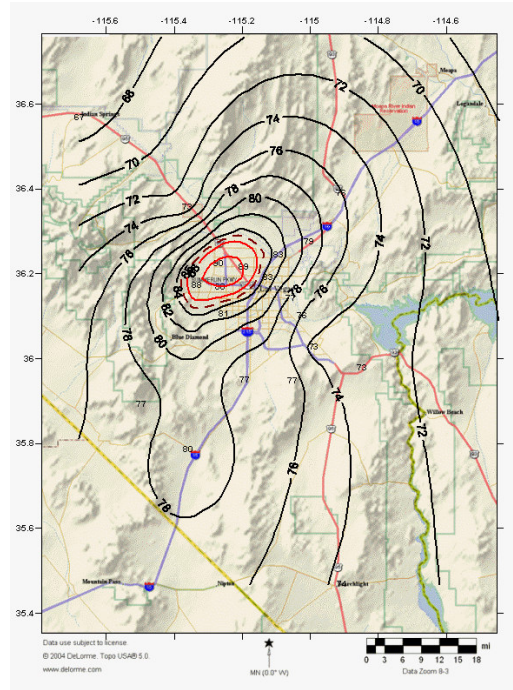
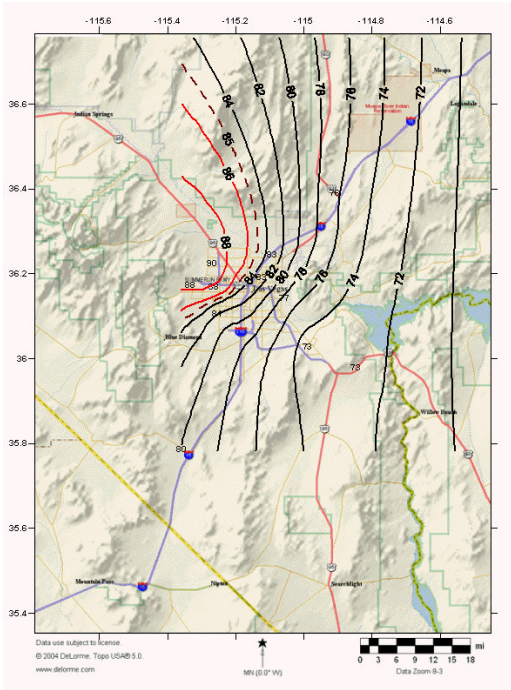

June 12, 2005

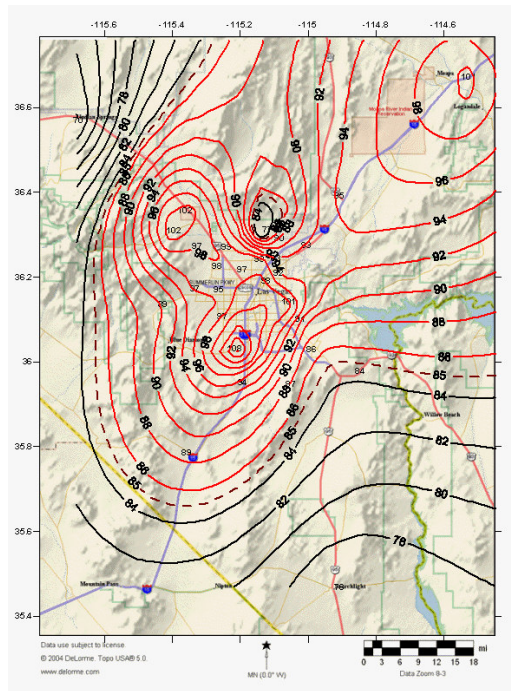
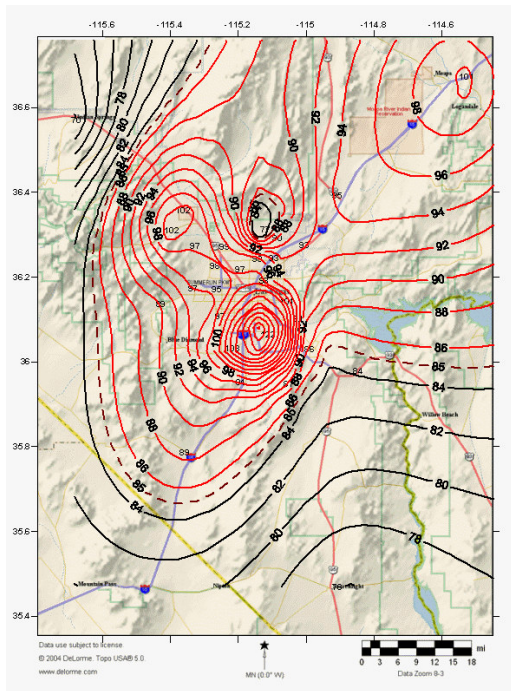
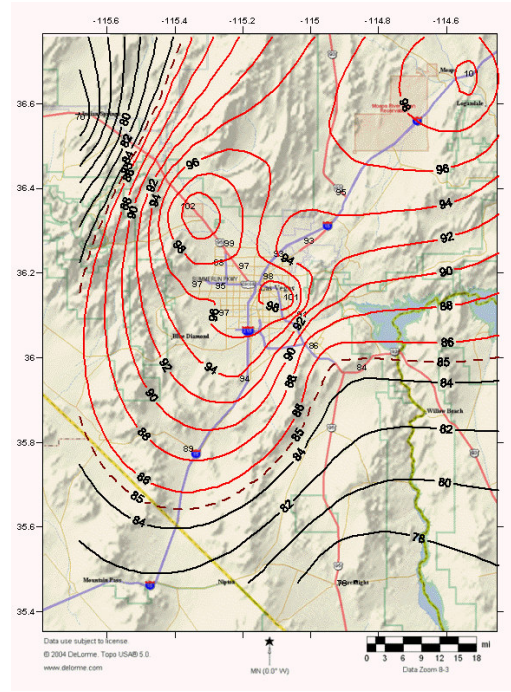
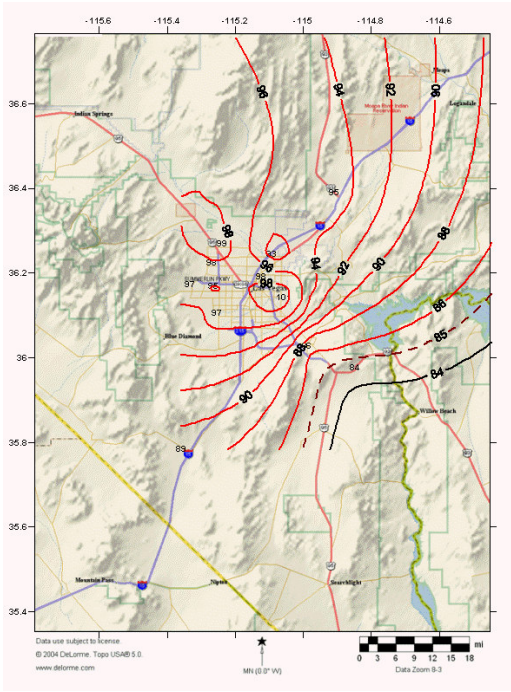

June 29, 2005

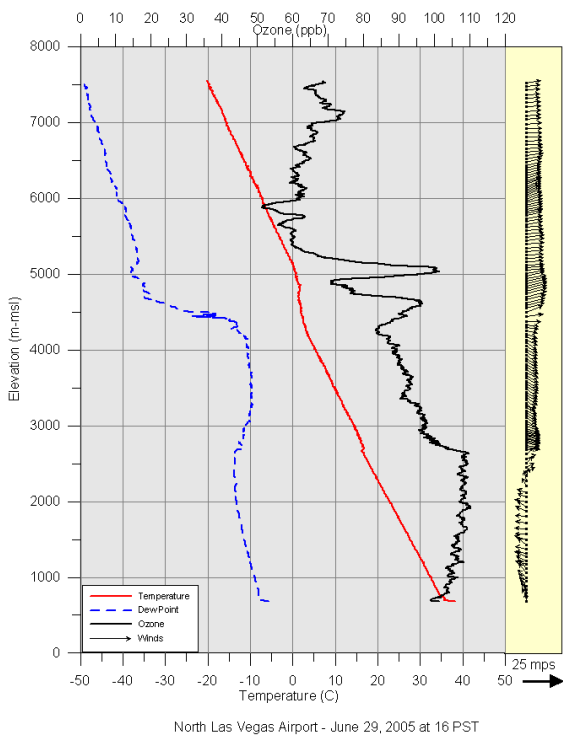
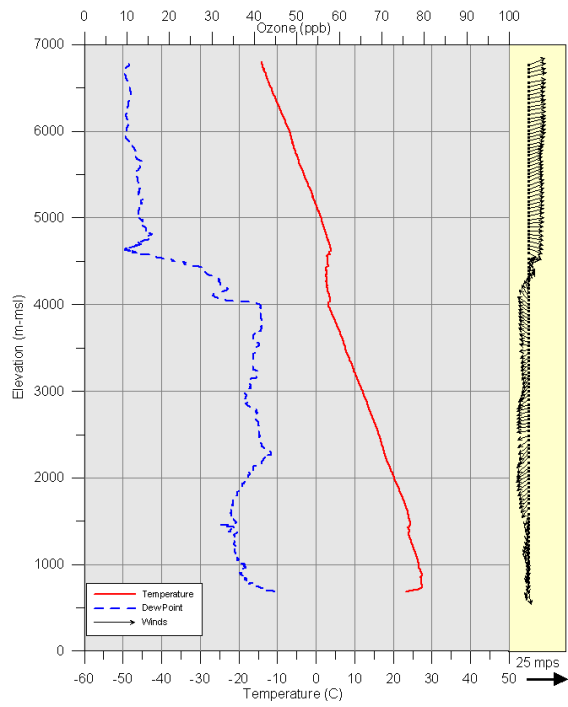
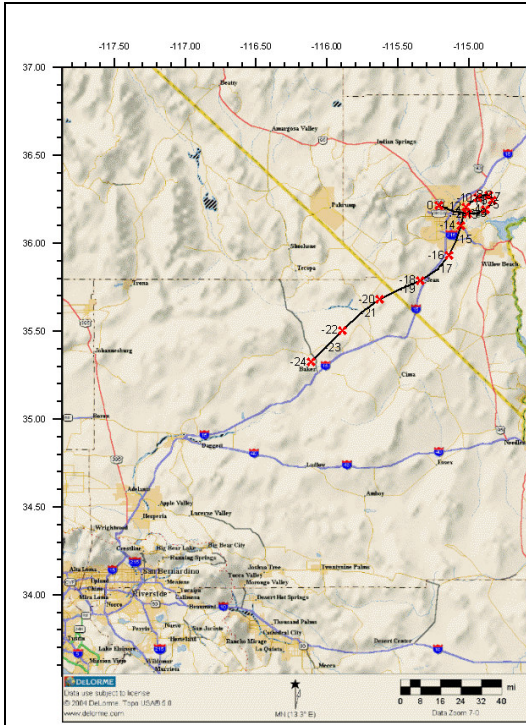

June 29, 2005

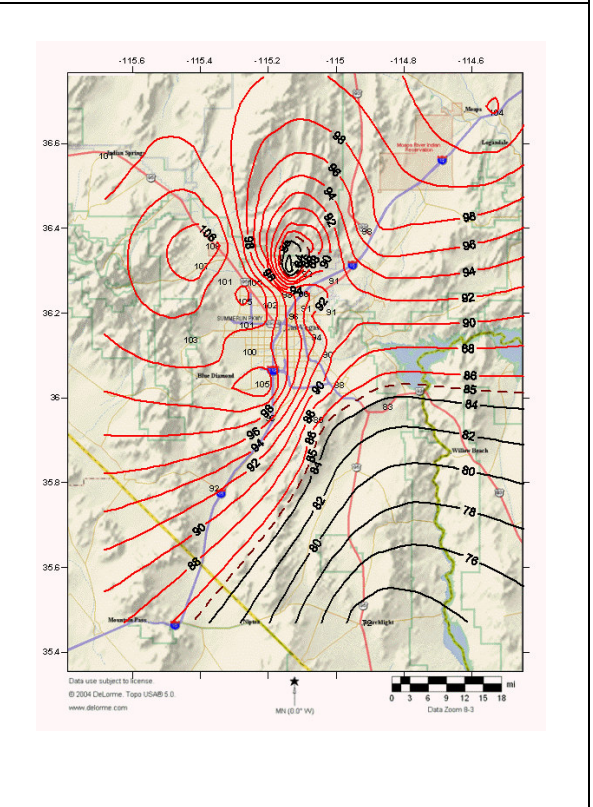
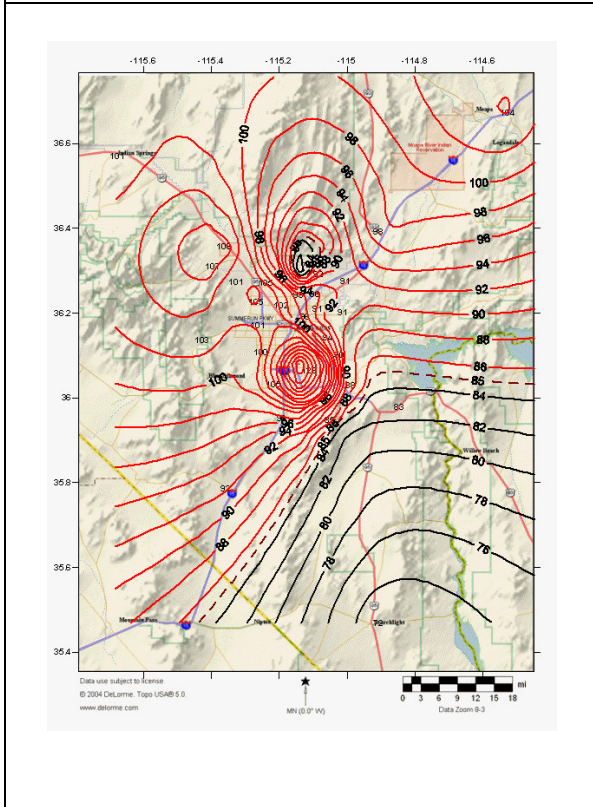
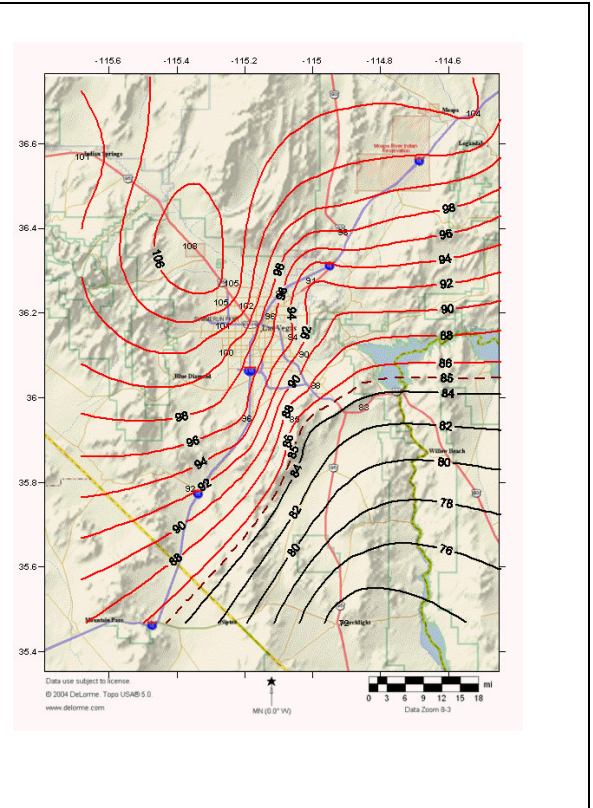
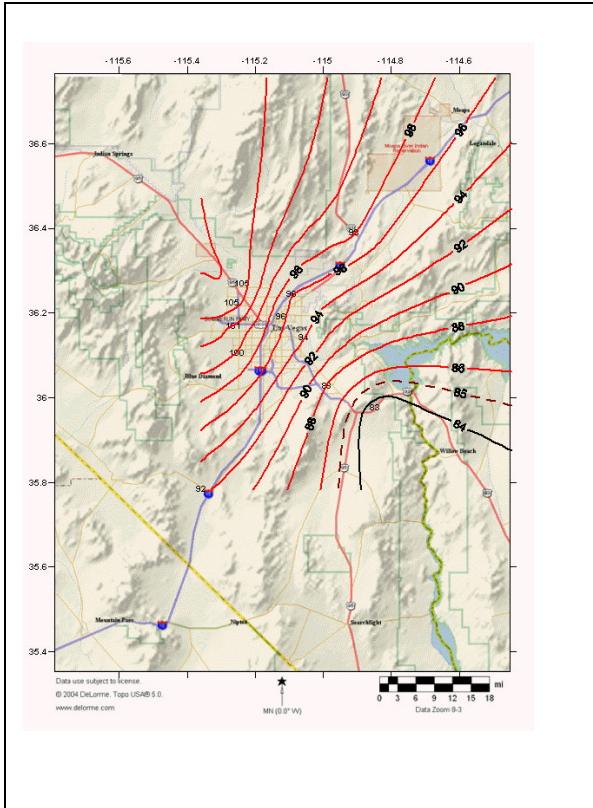

June 30, 2005

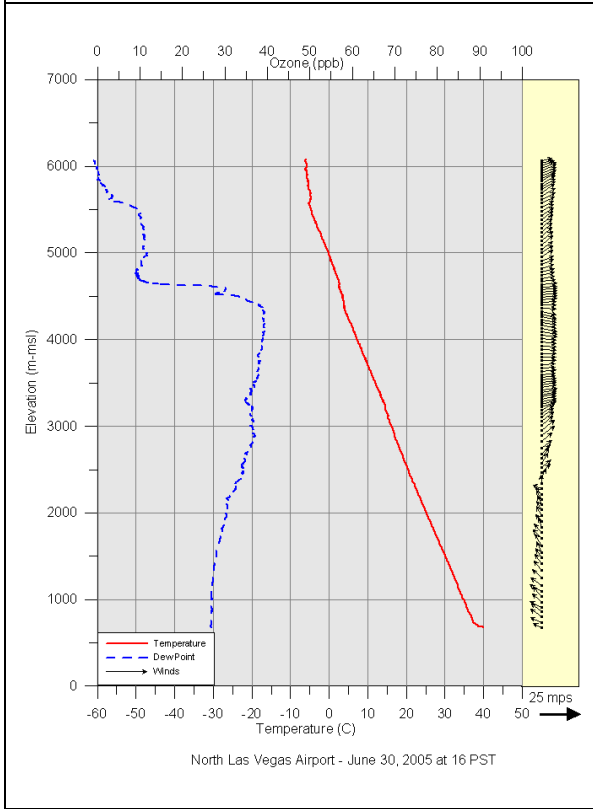
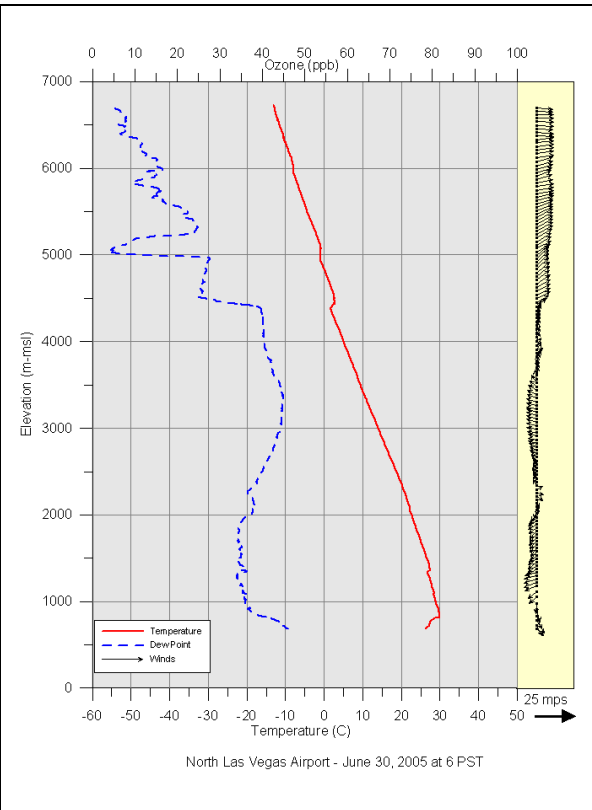
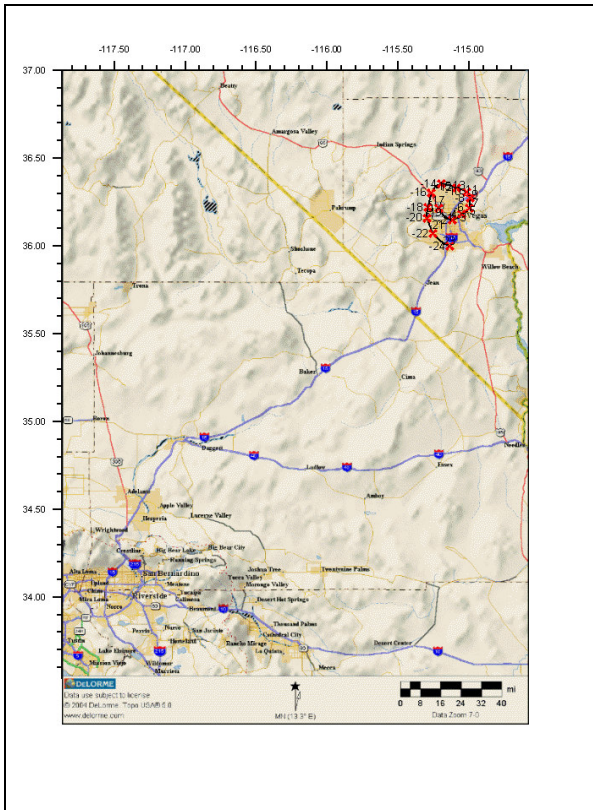

June 30, 2005

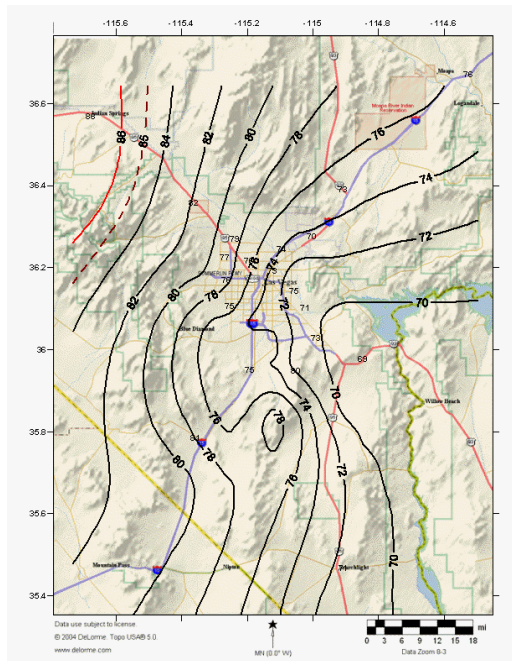
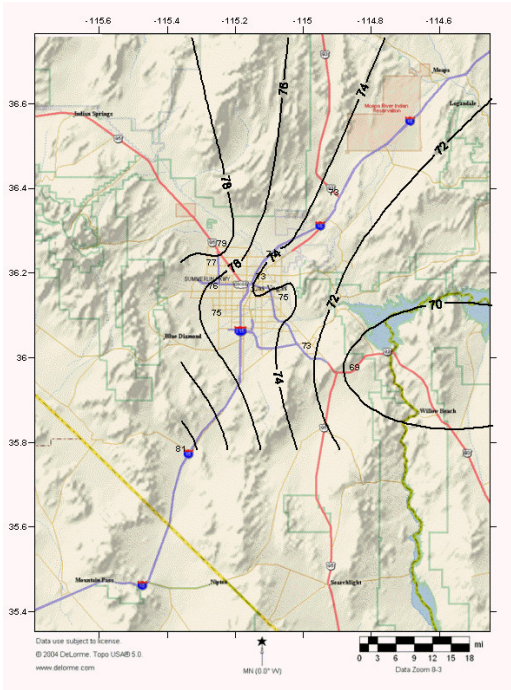

July 1, 2005 Peak 8-hour Ozone Levels
Supplemental + DAGEM sites

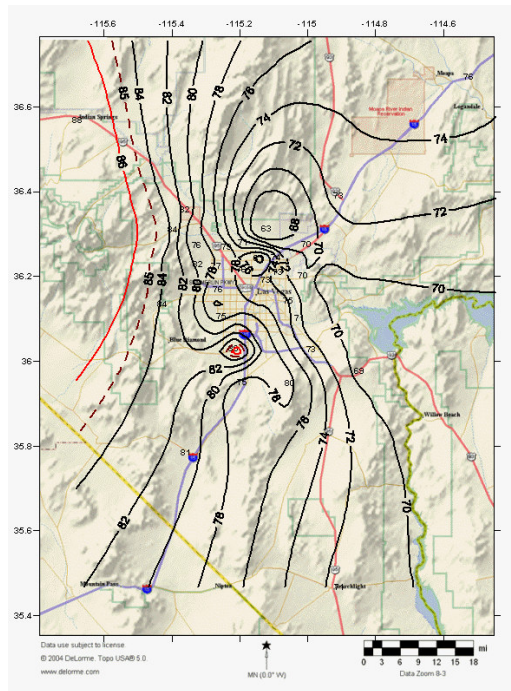
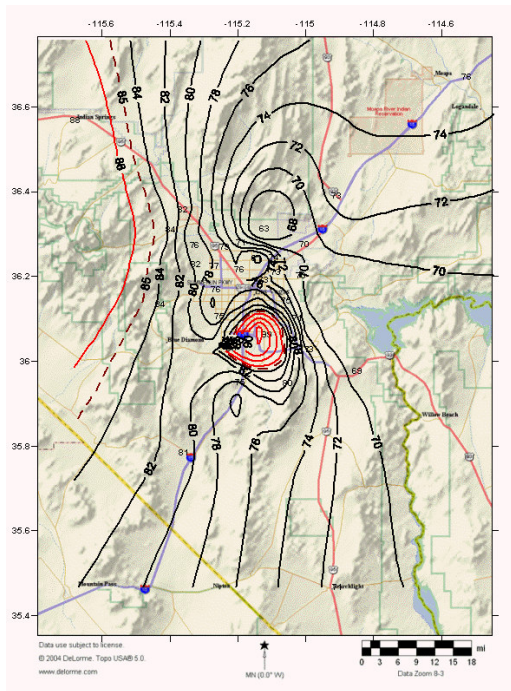

July 1, 2005

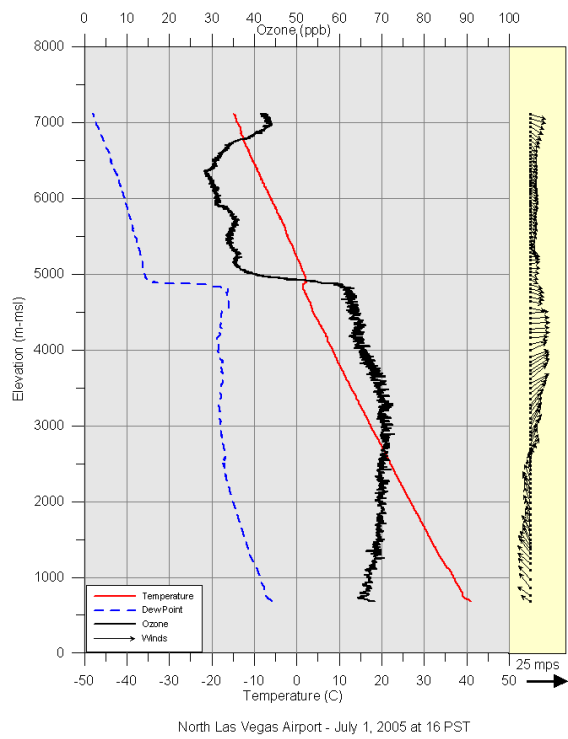
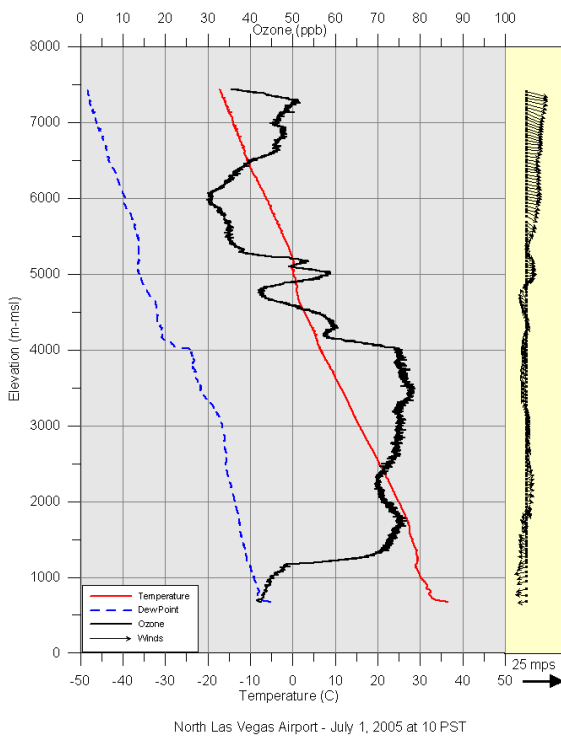
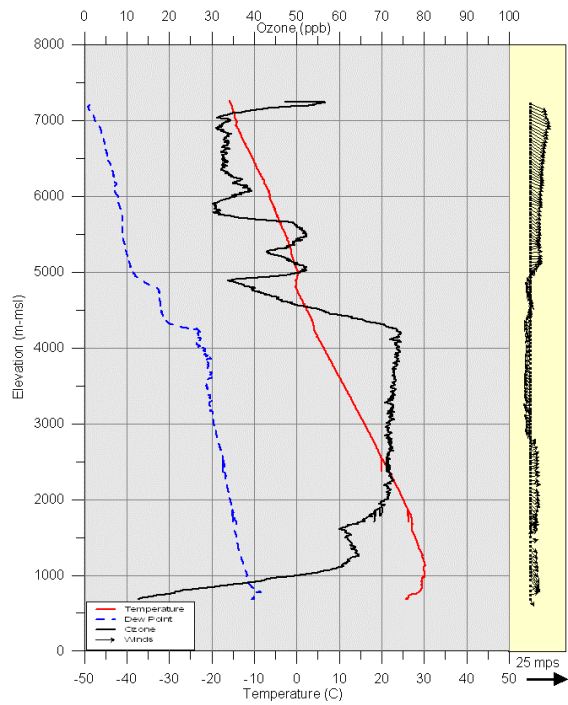
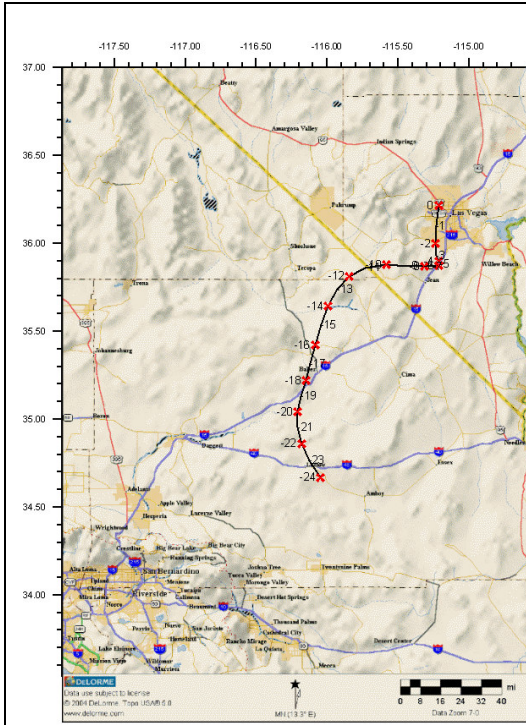

July 1, 2005

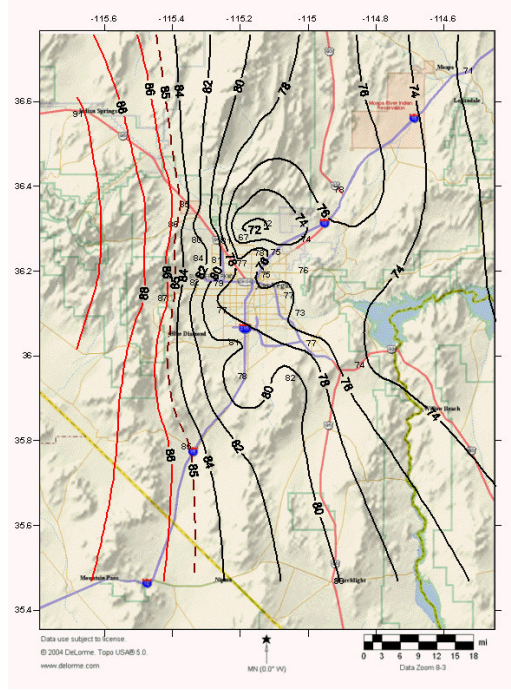
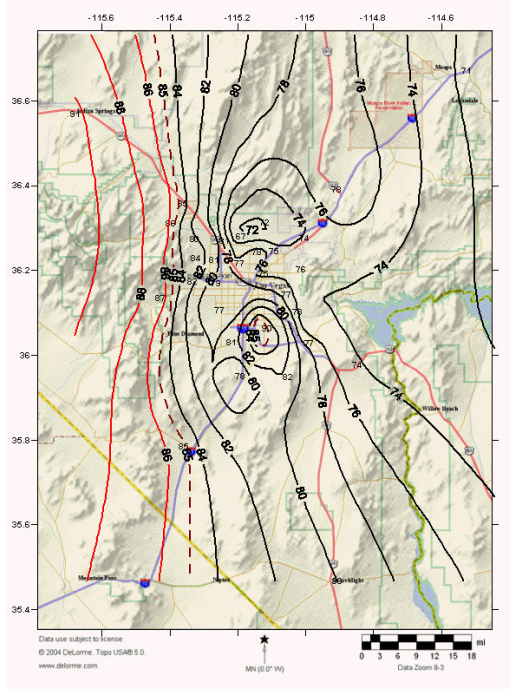
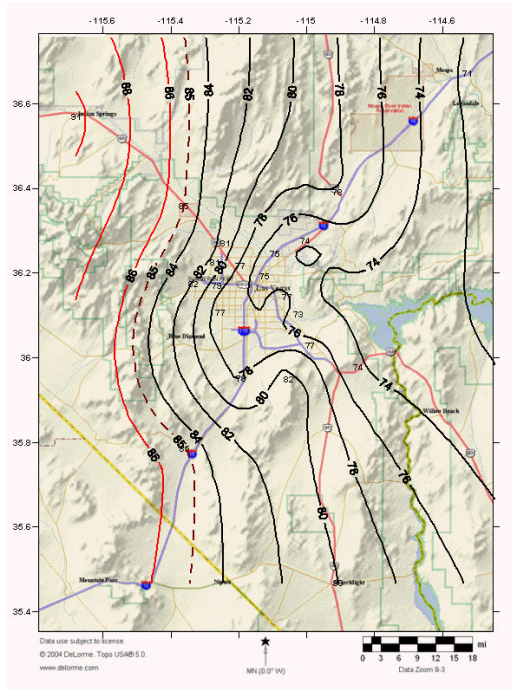
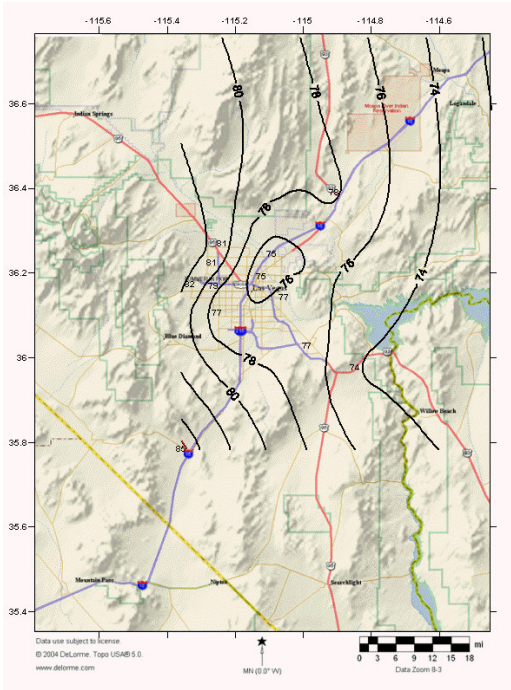

July 2, 2005

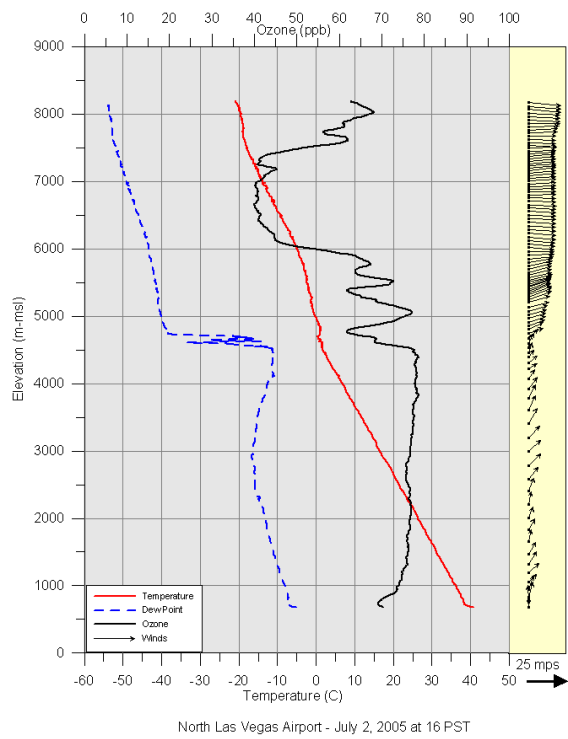
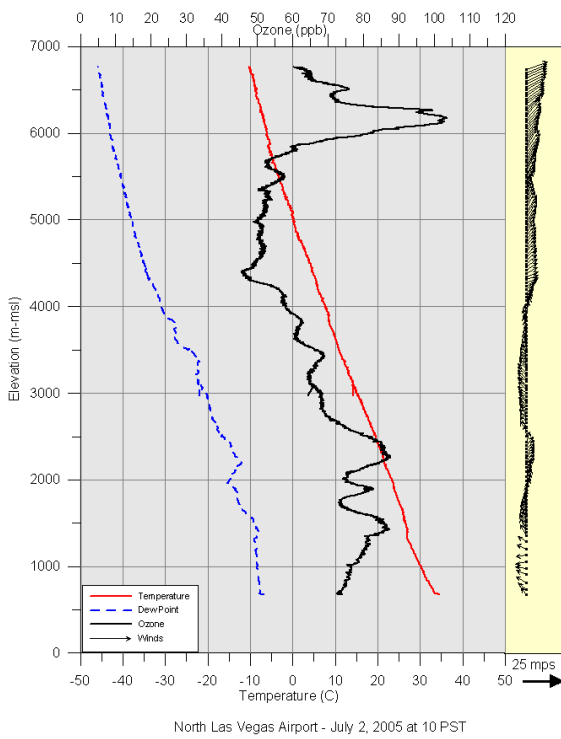
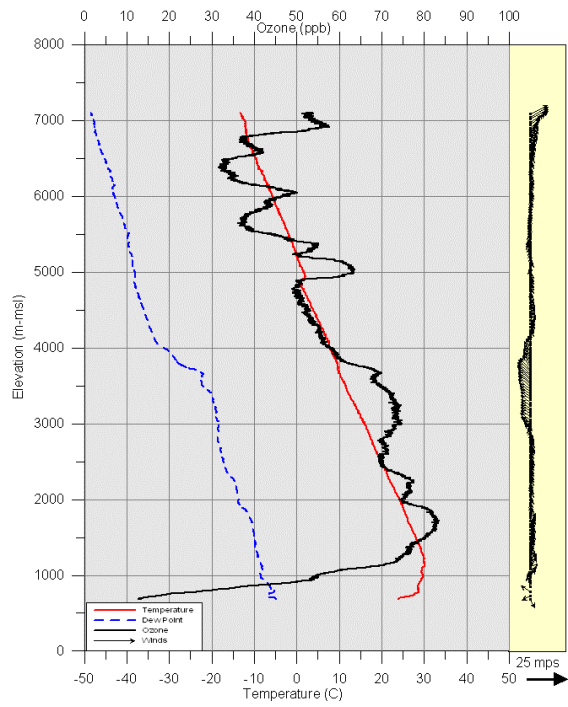
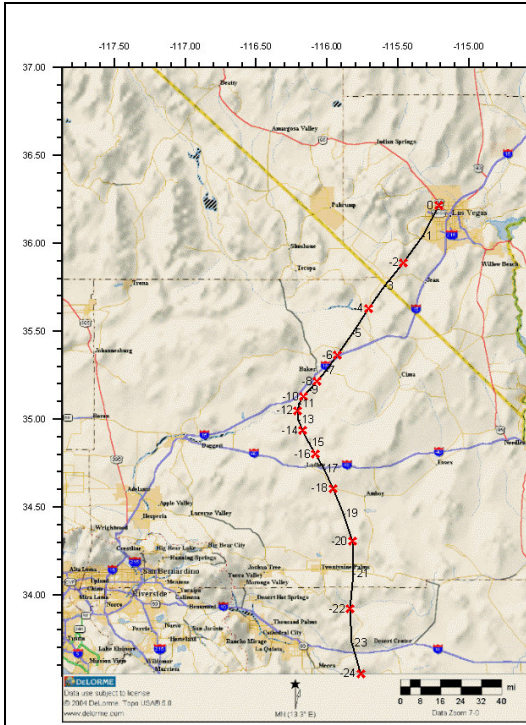

July 2, 2005

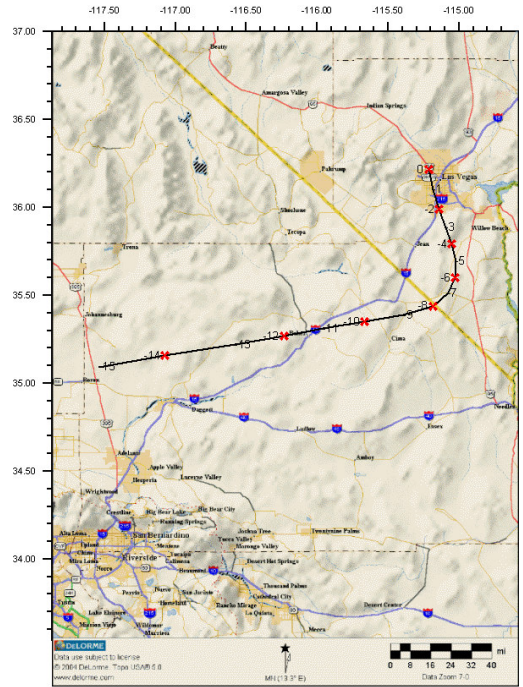
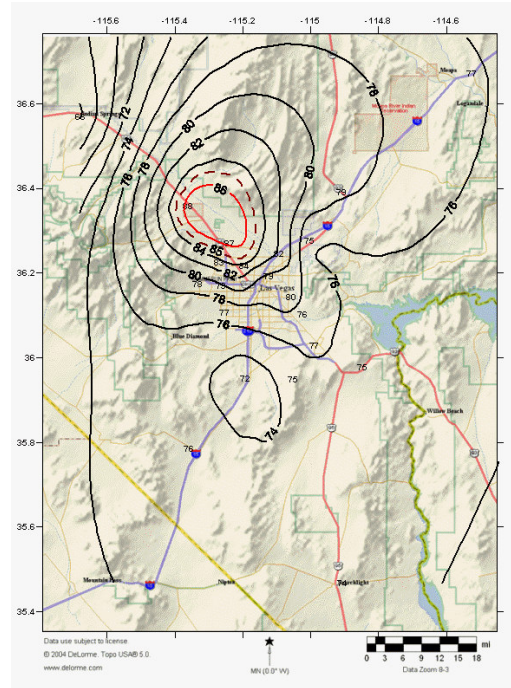
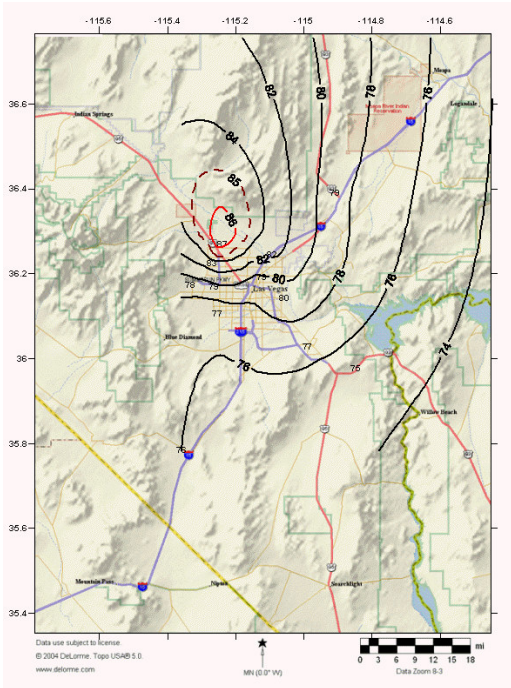

July 3, 2005

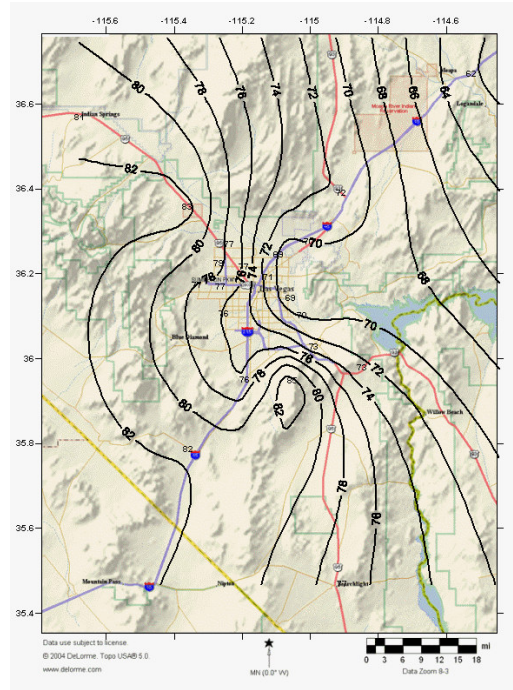
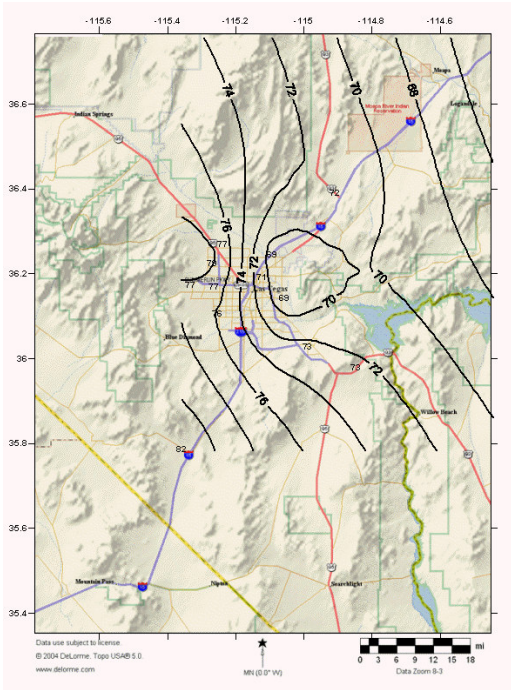

July 6, 2005

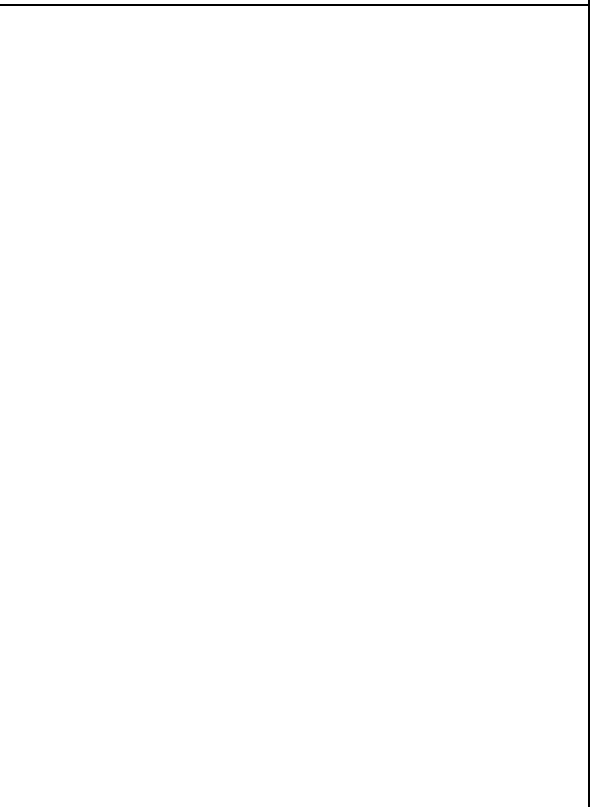
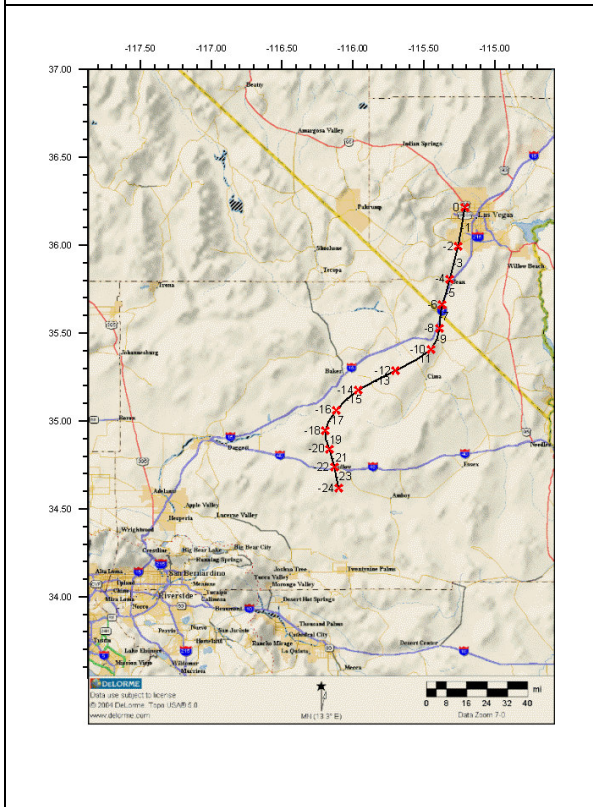
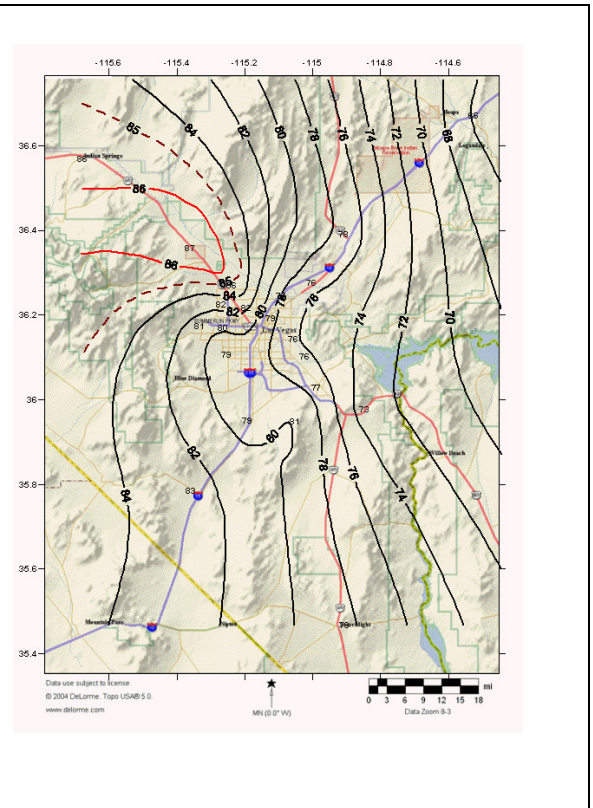
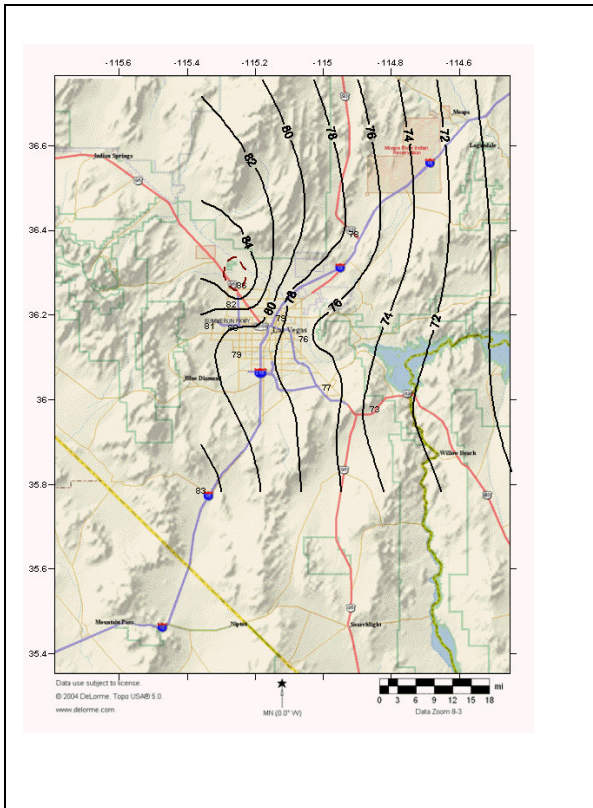

July 6, 2005

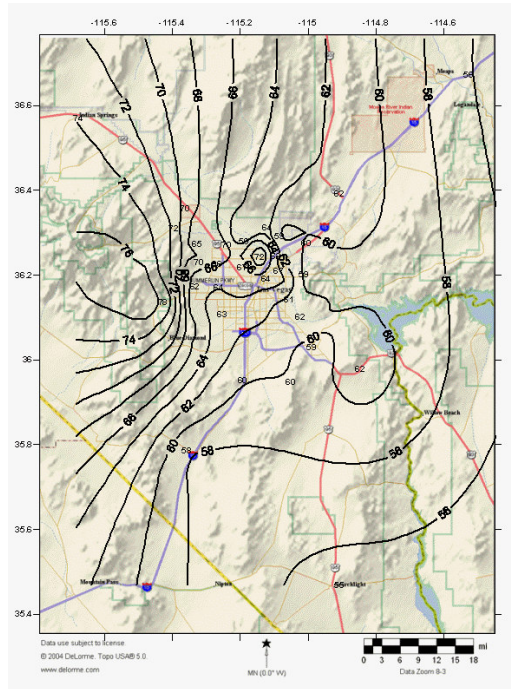
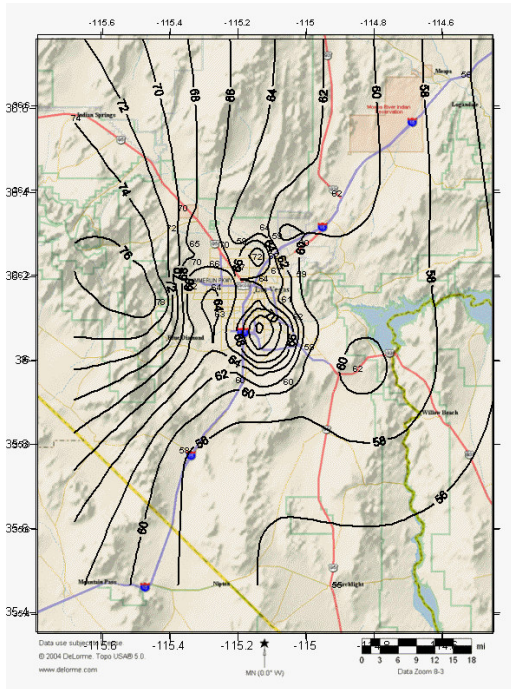
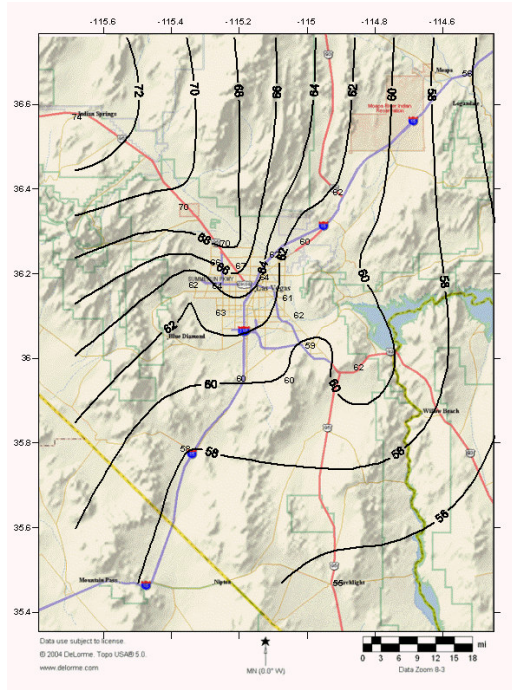
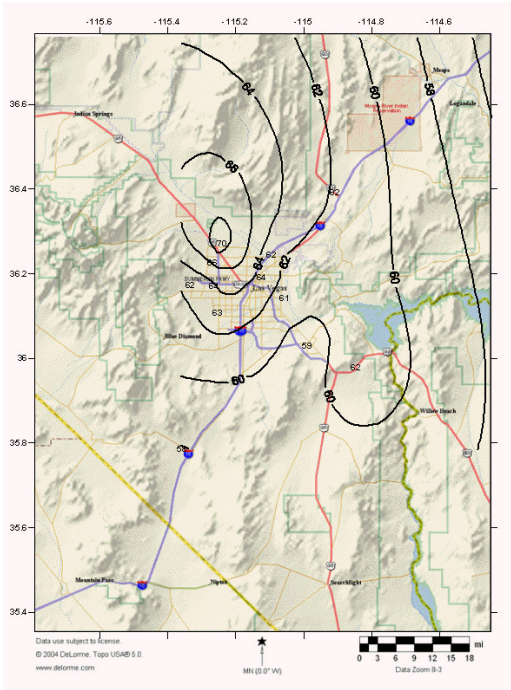

July 12, 2005

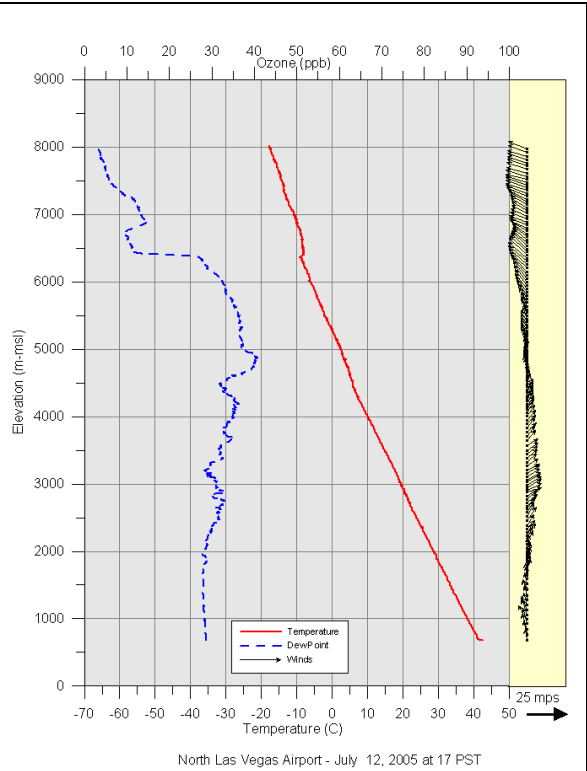
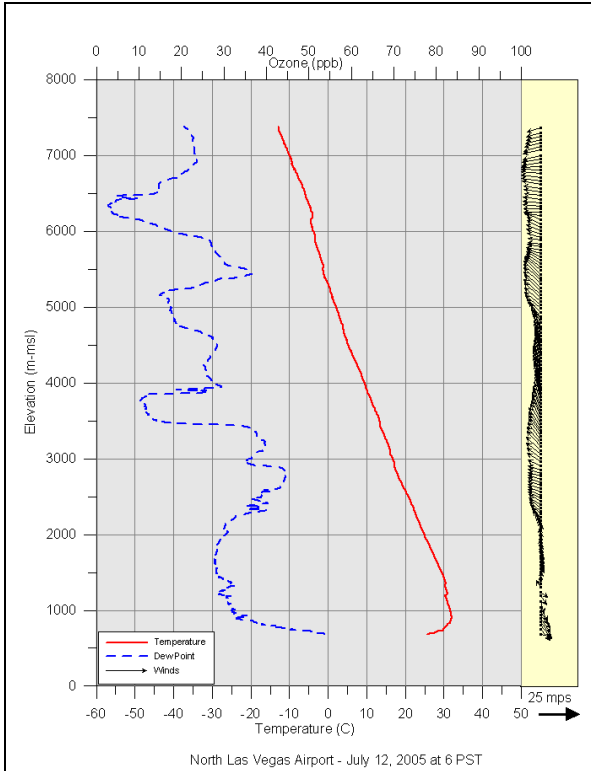

July 12, 2005

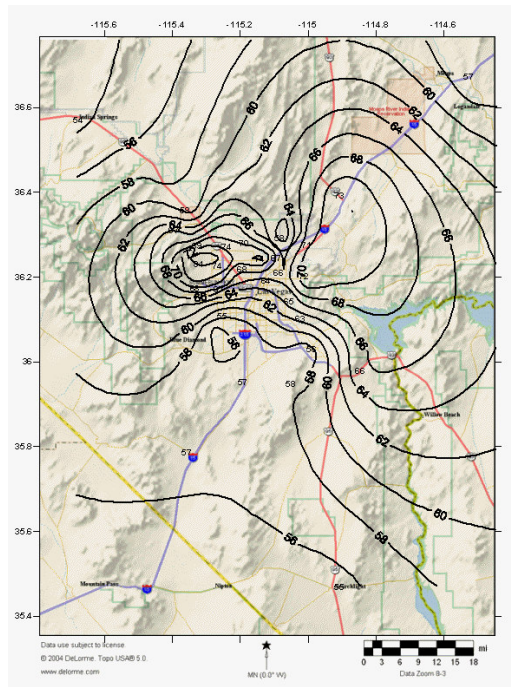
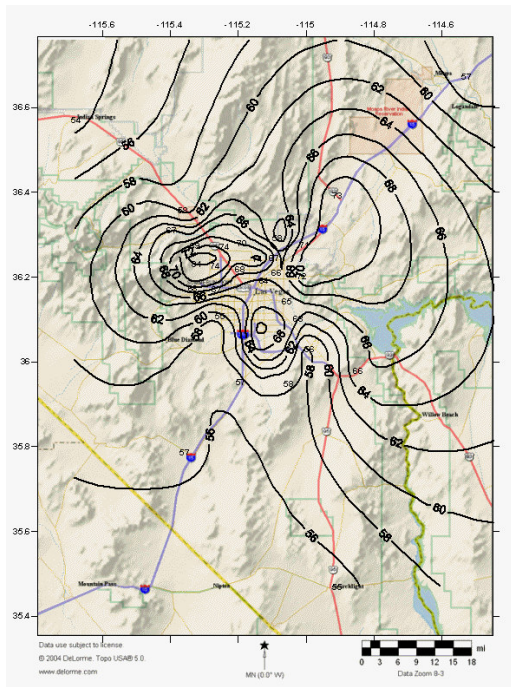
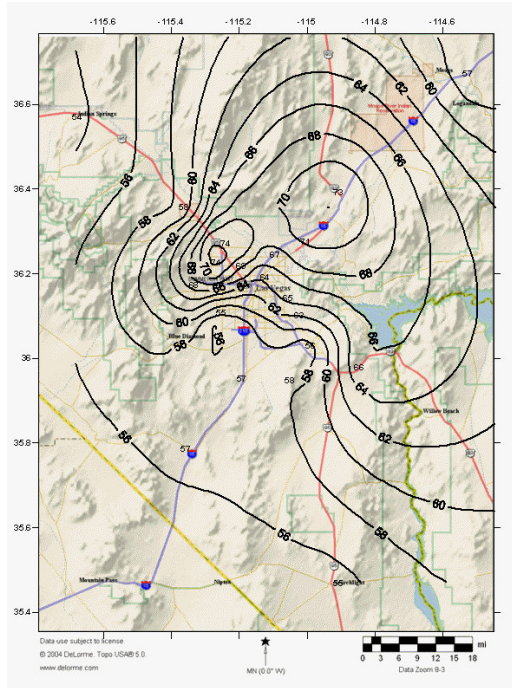
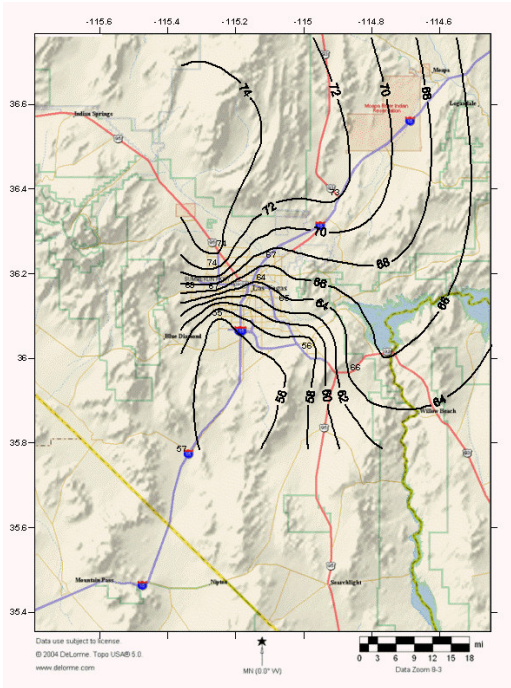

July 13, 2005

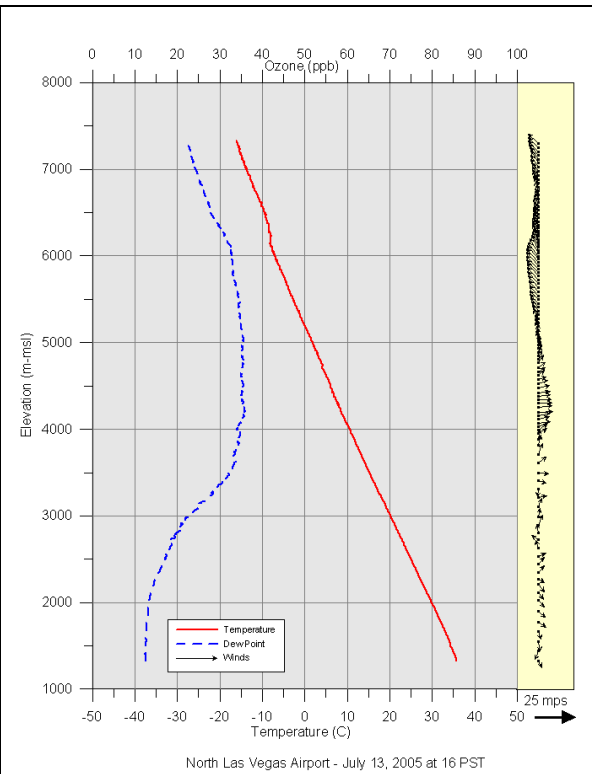
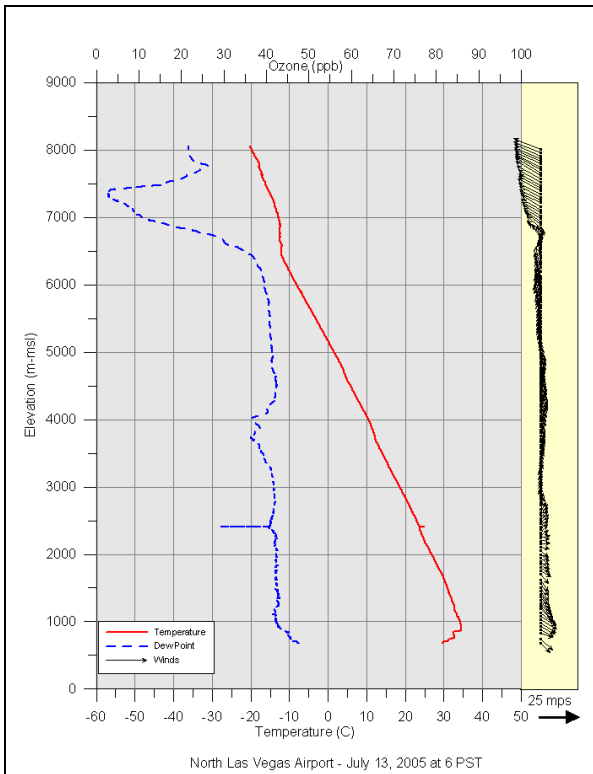

July 13, 2005

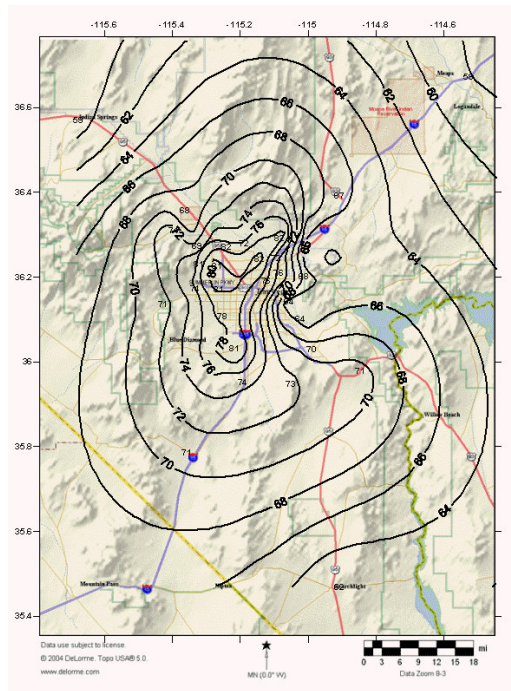
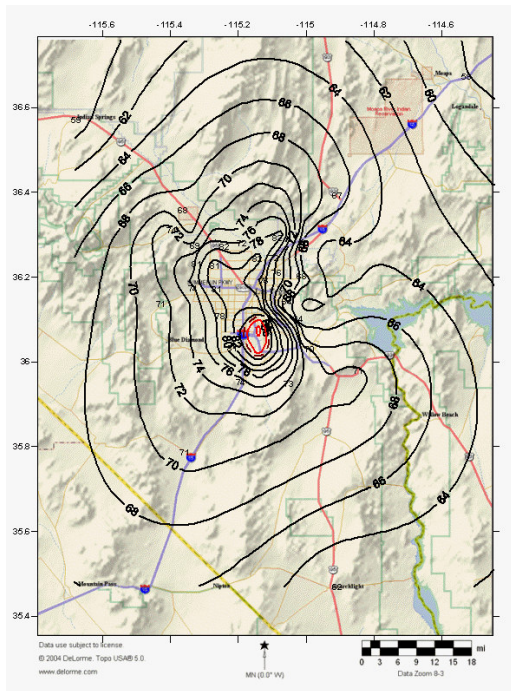
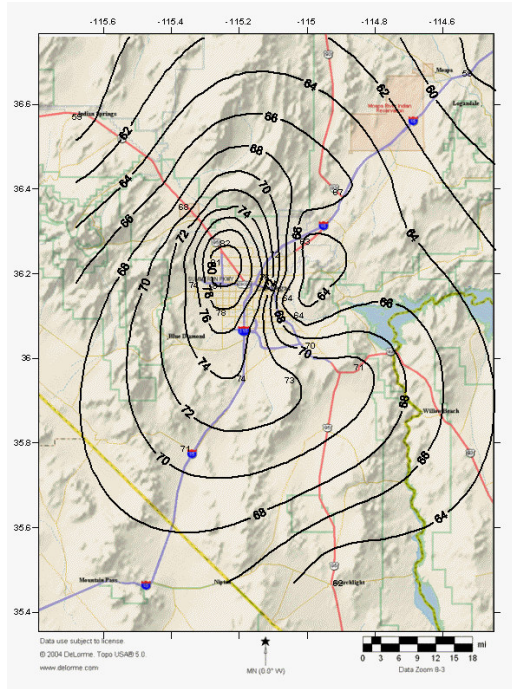
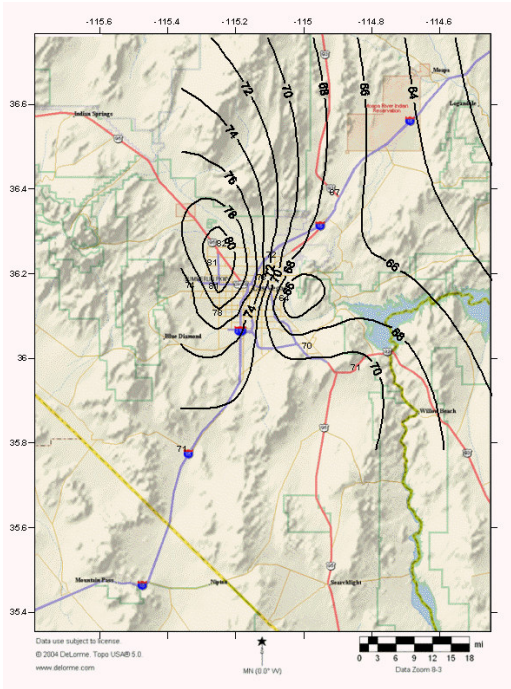

July 14, 2005

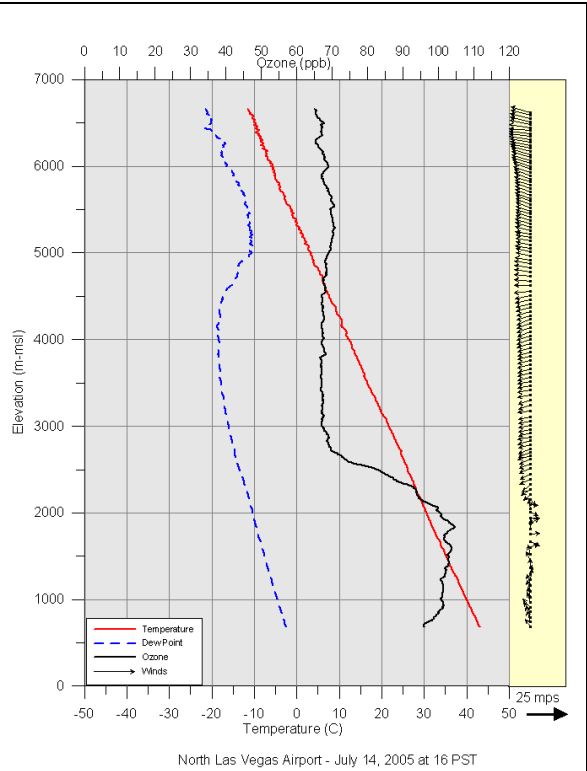
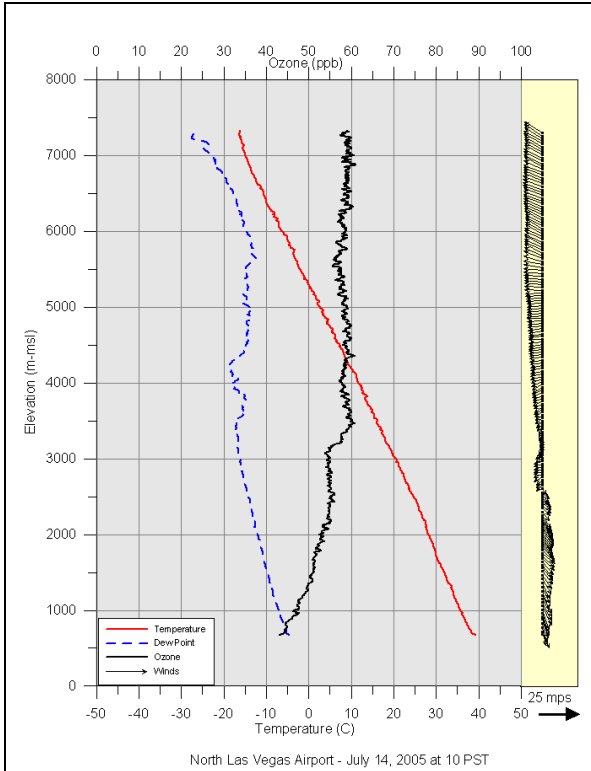

July 14, 2005

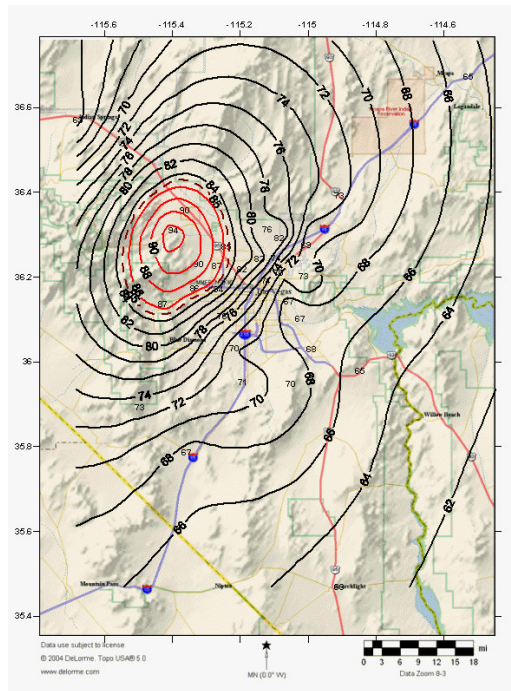
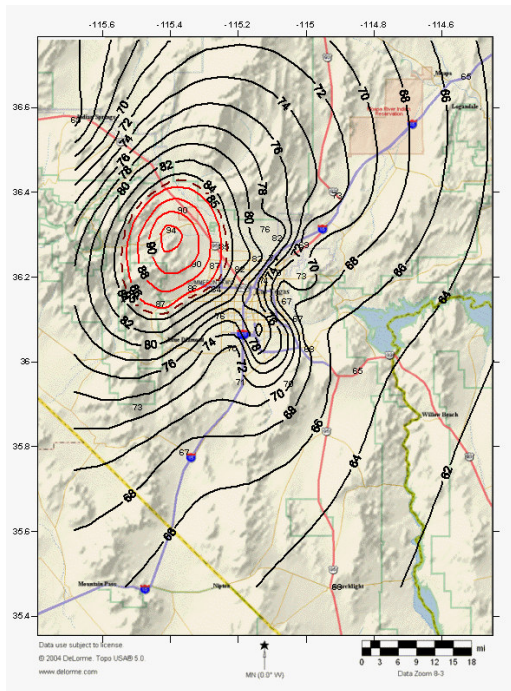
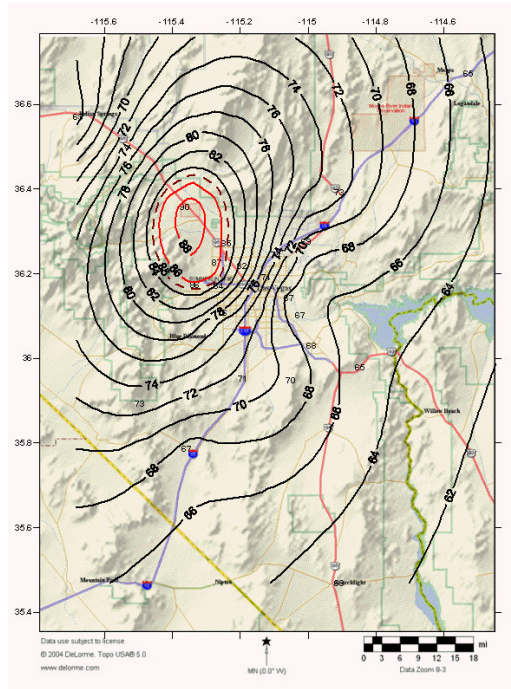
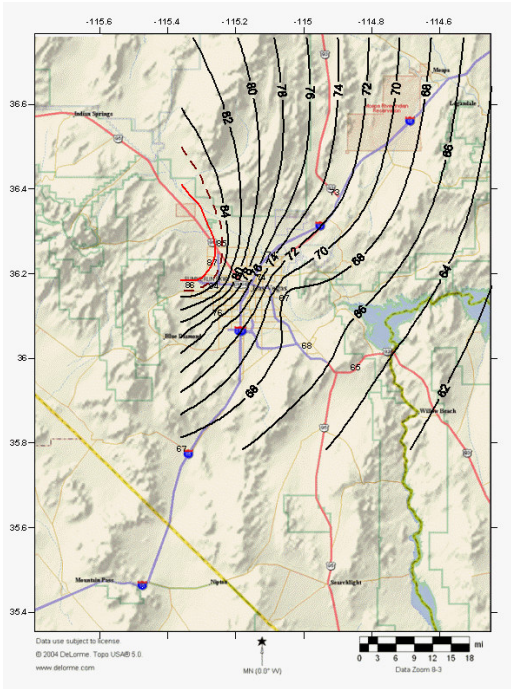

July 15, 2005

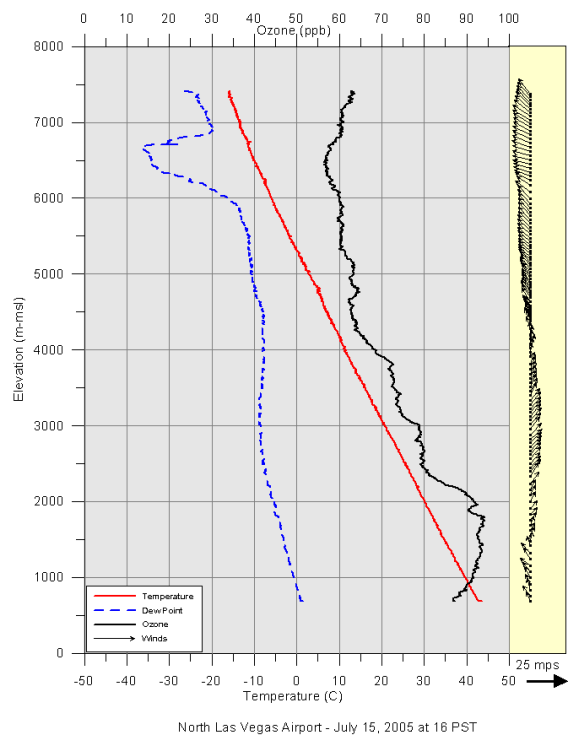
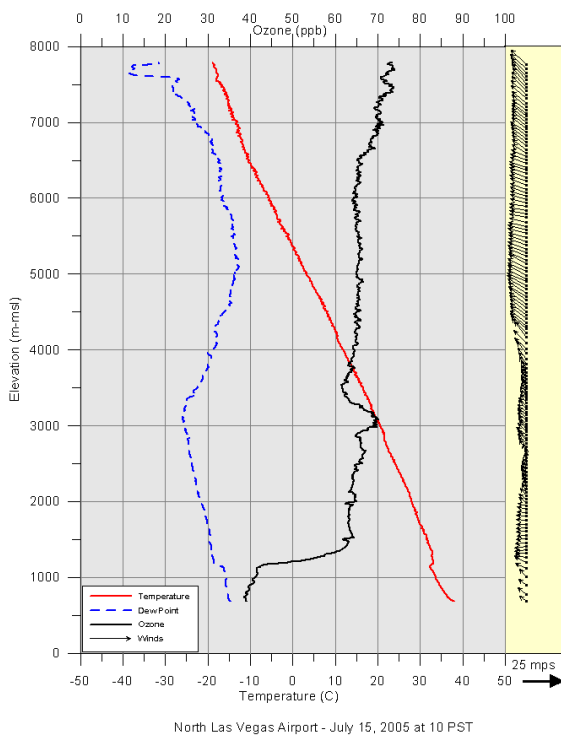
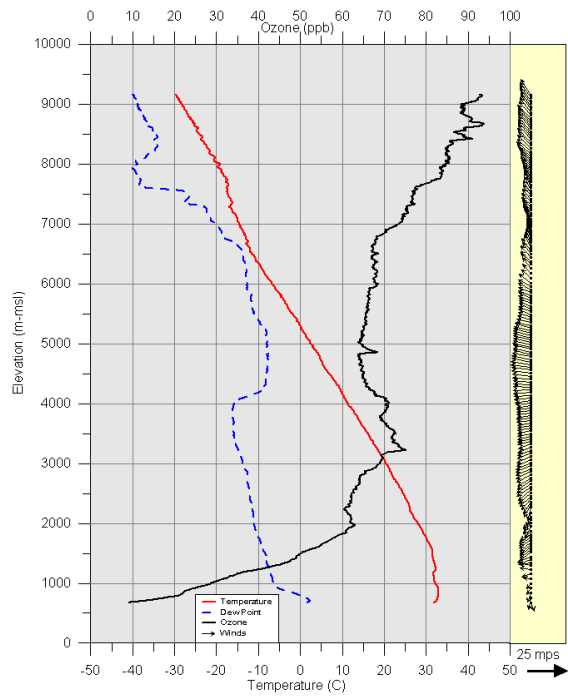
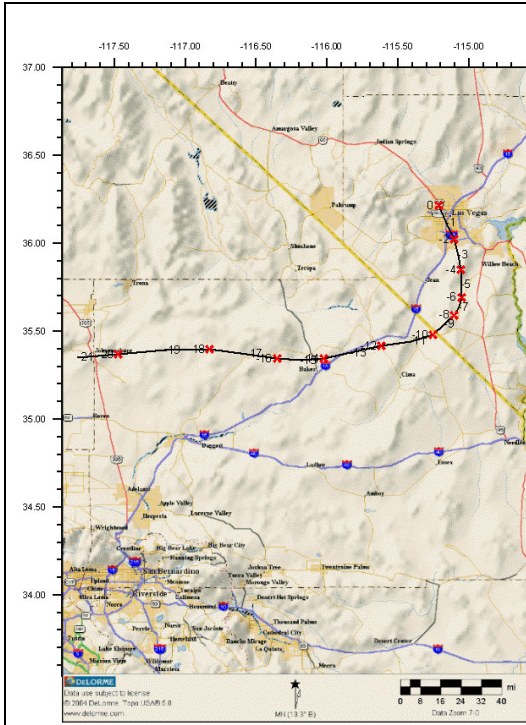

July 15, 2005

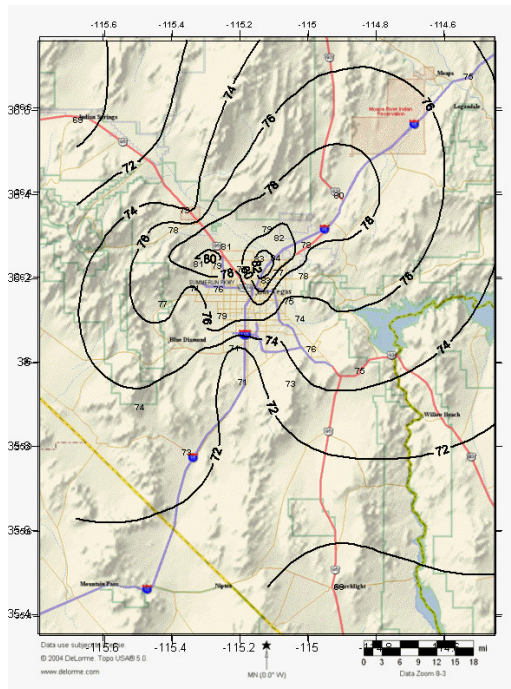
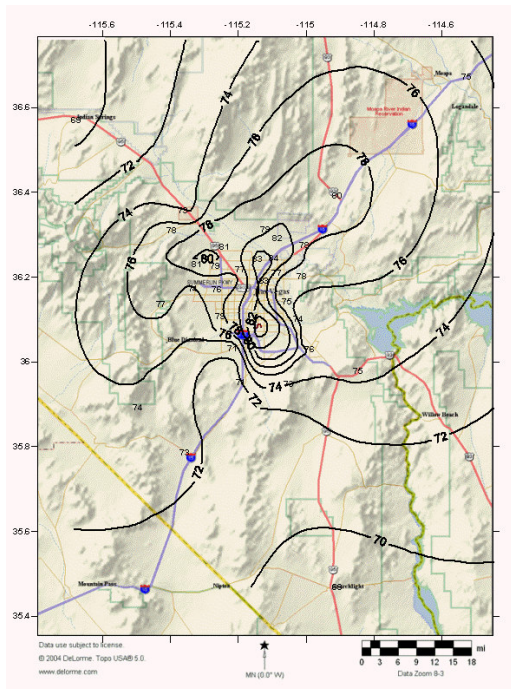
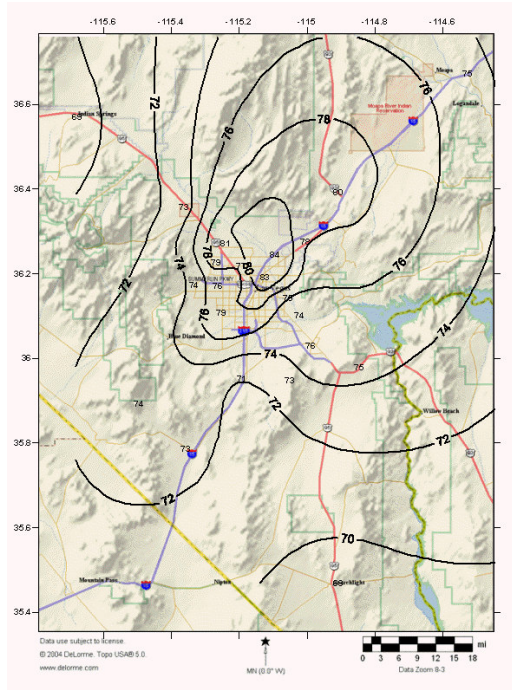
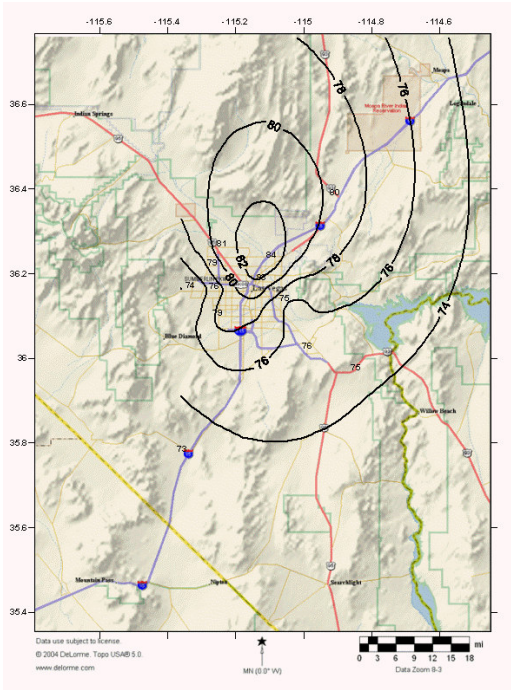

July 16, 2005

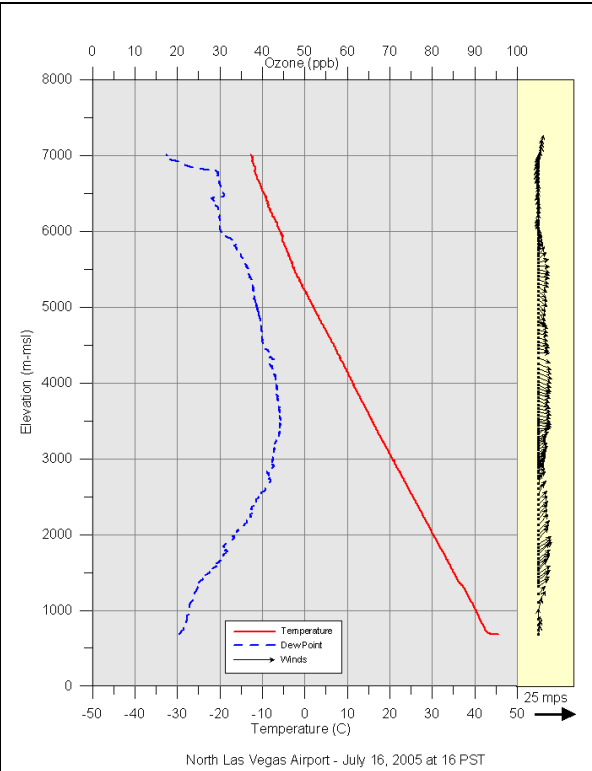
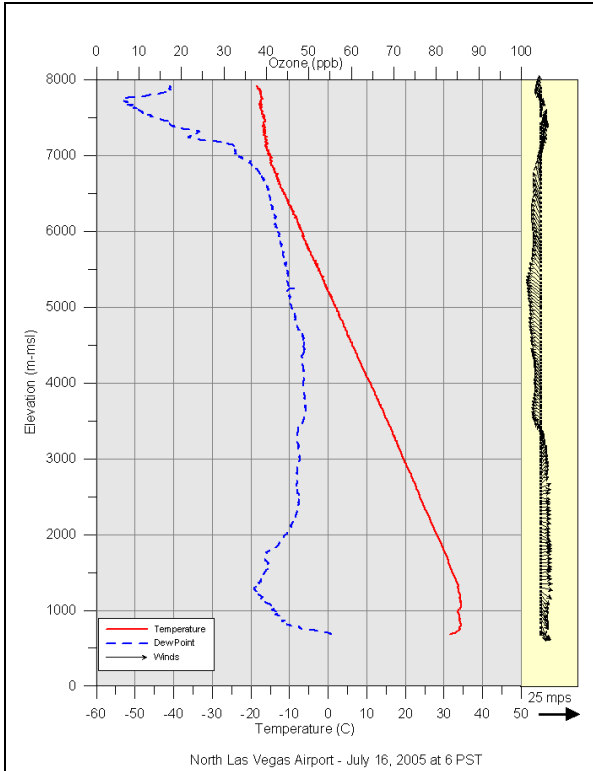

July 16, 2005

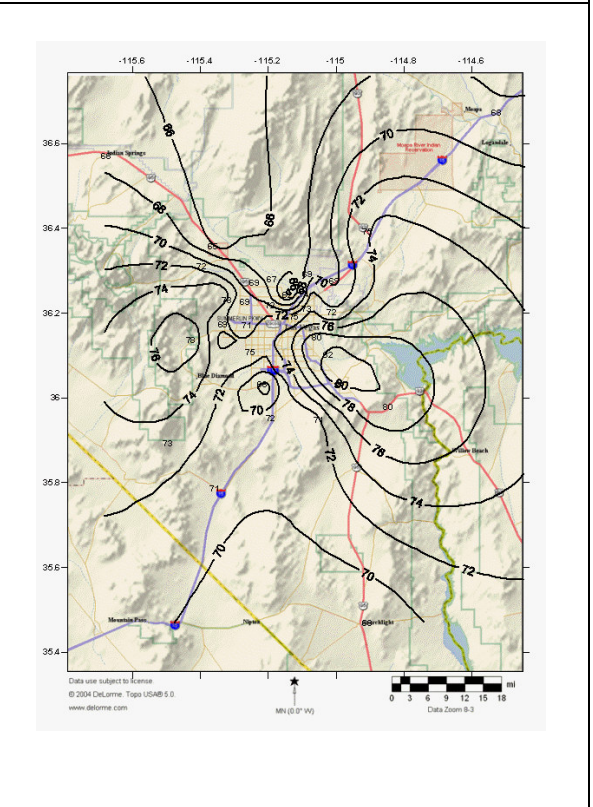
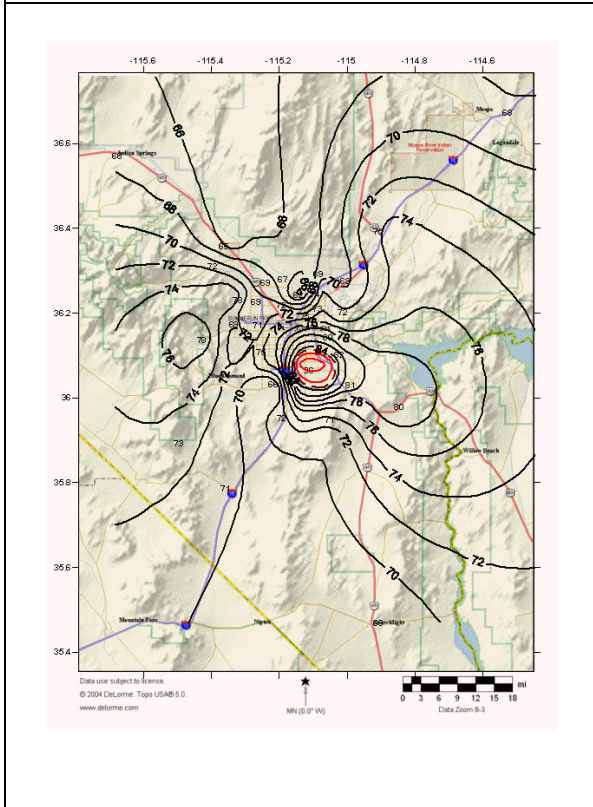
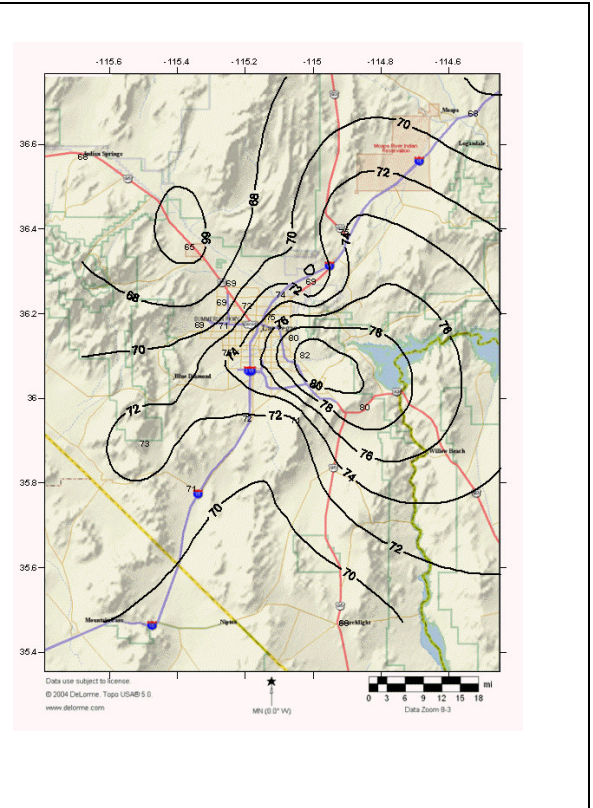
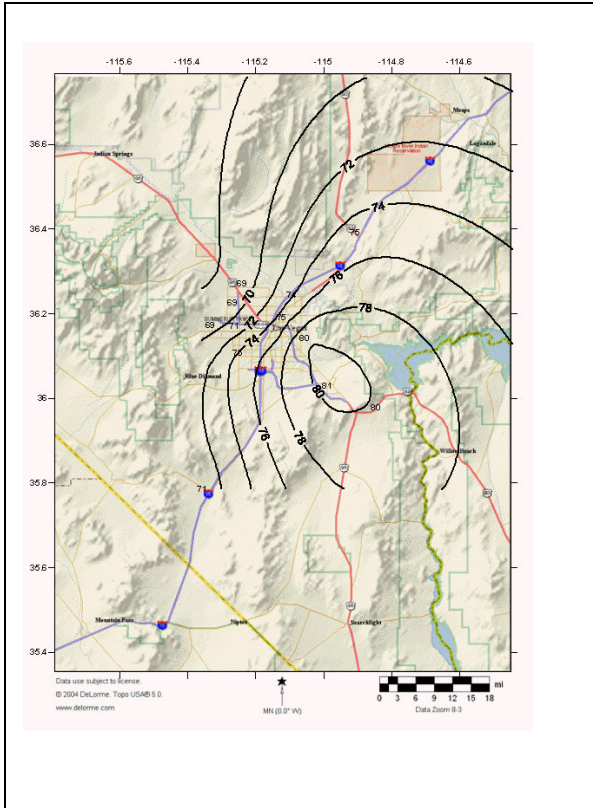

July 17, 2005

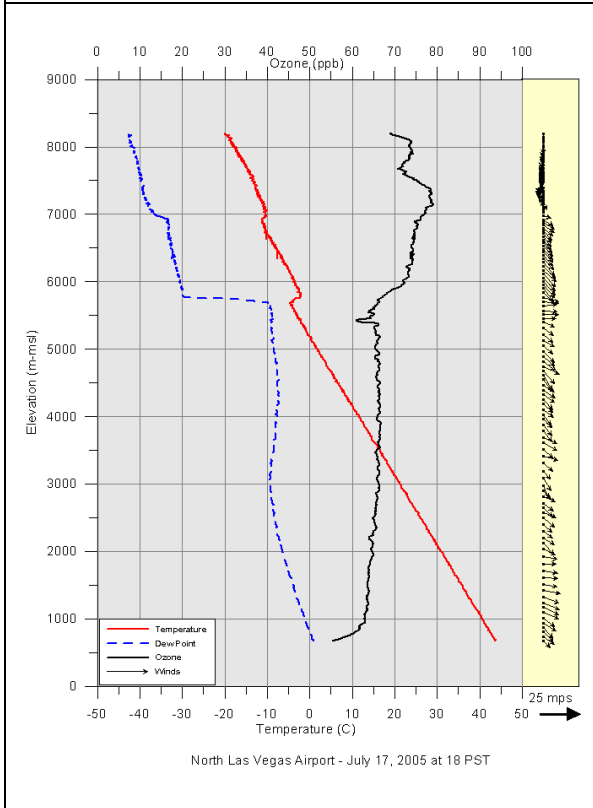
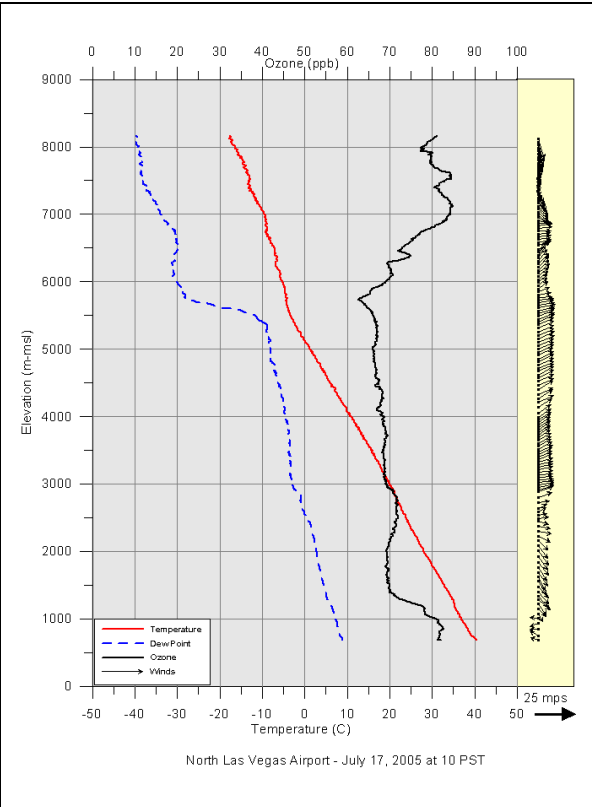
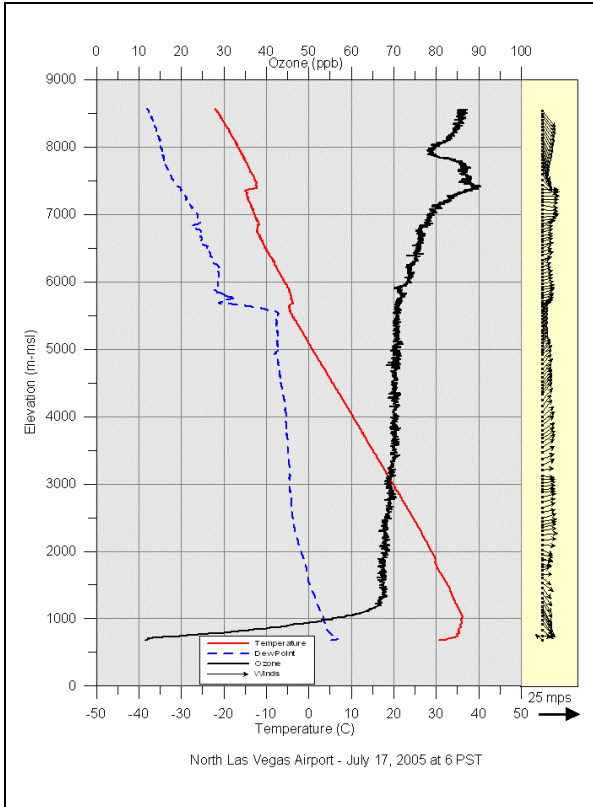

July 17, 2005

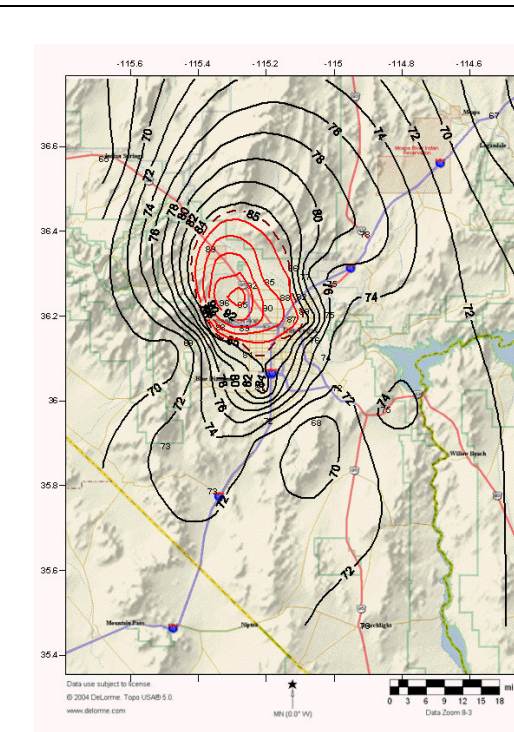
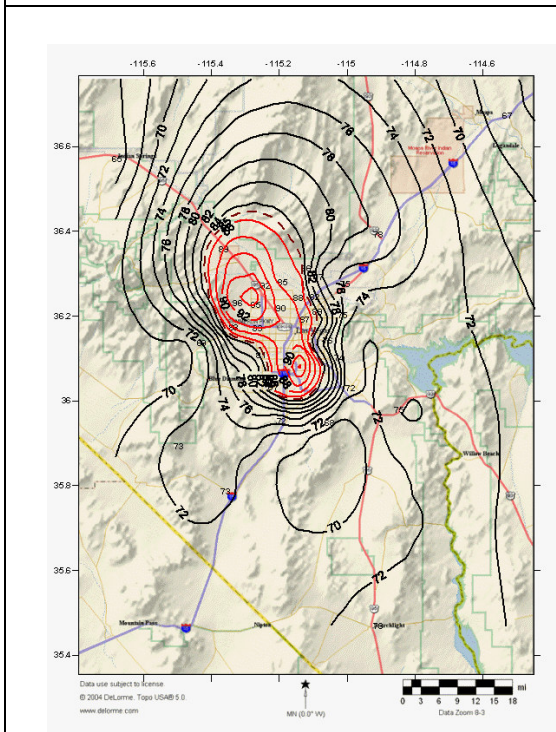
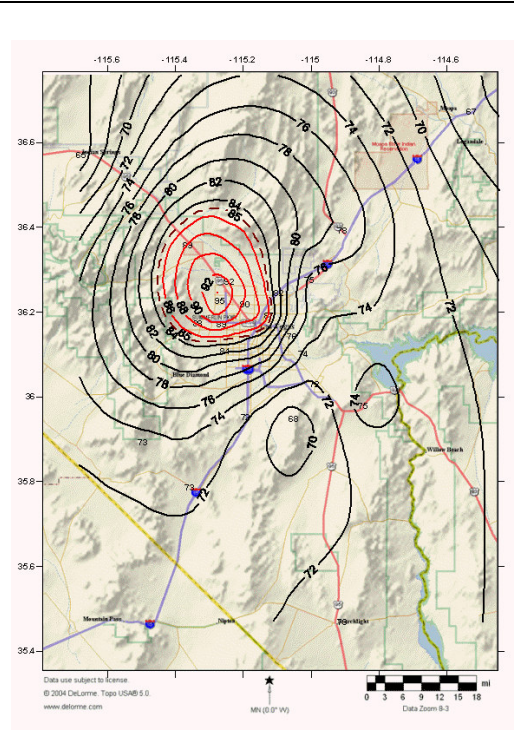
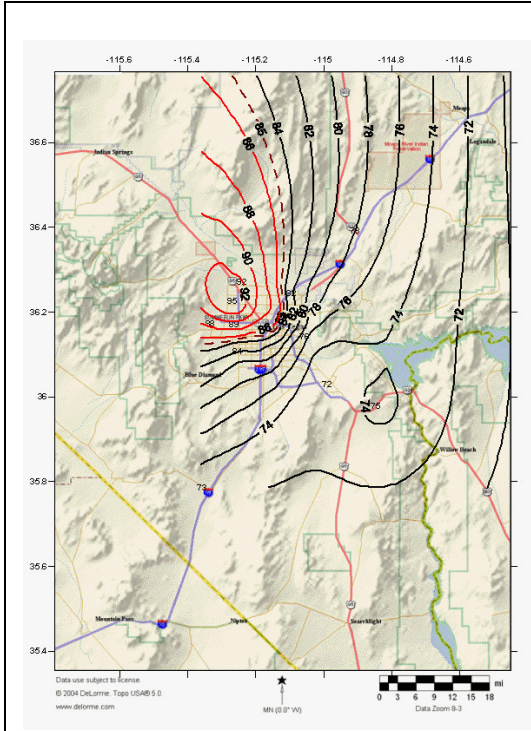

July 18, 2005

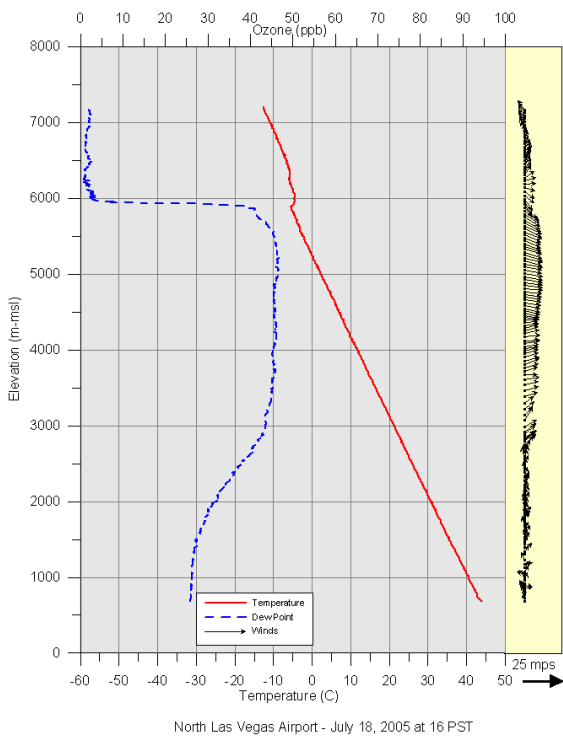
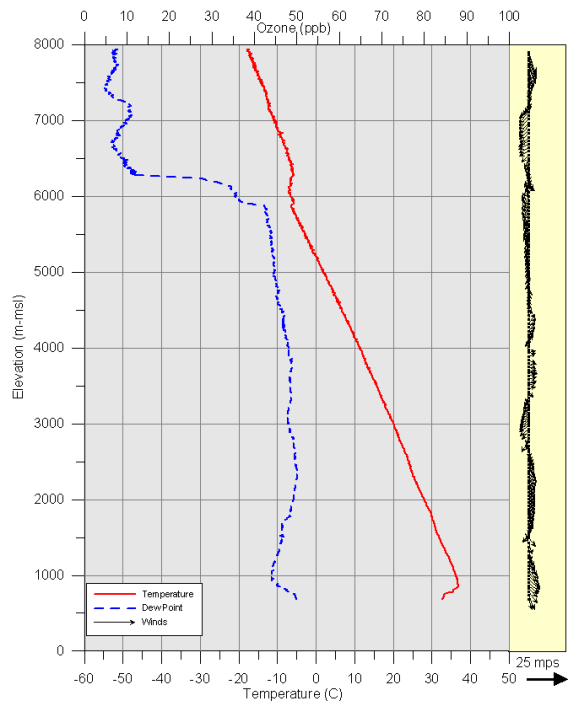
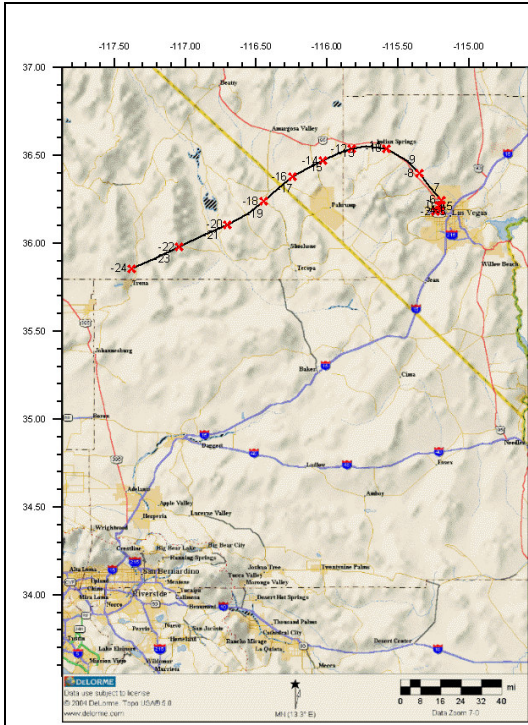

July 18, 2005

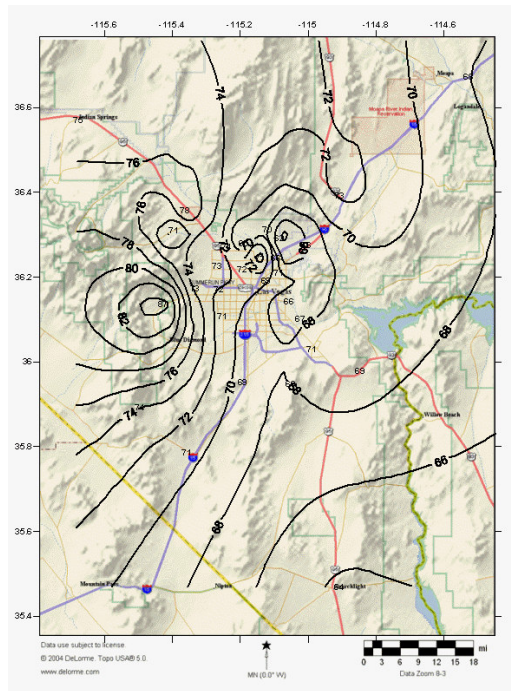
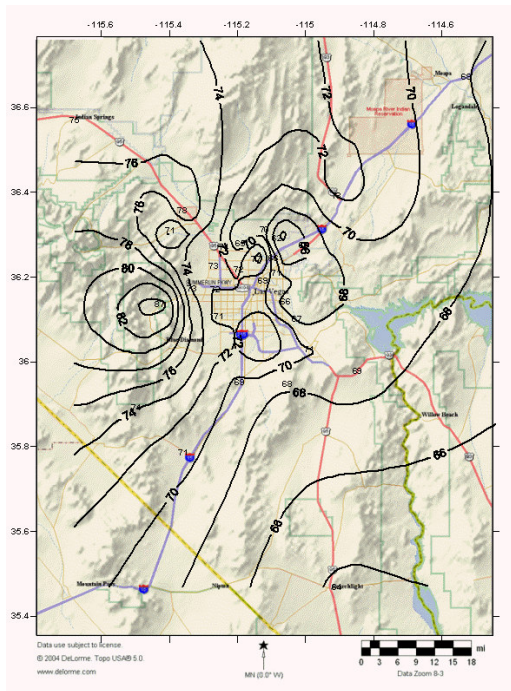
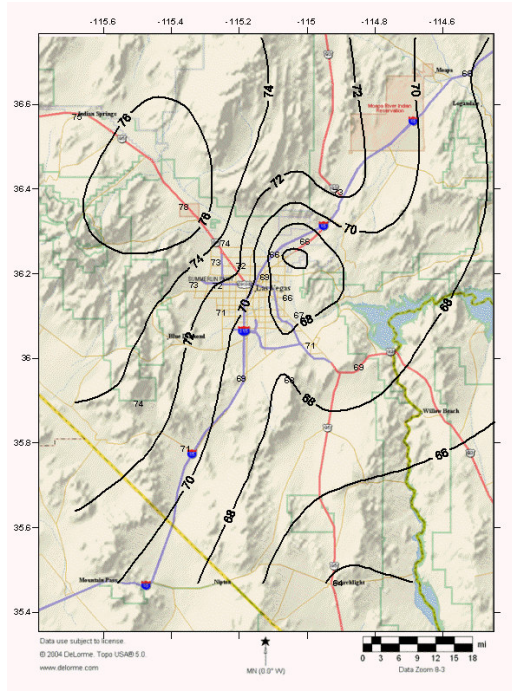
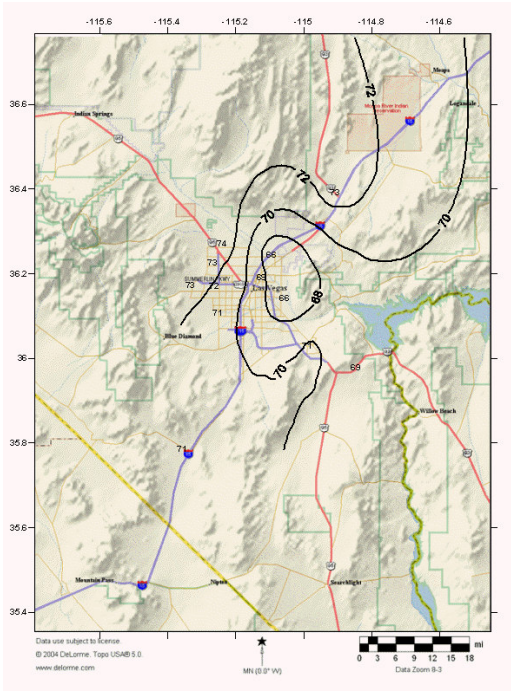

July 19, 2005

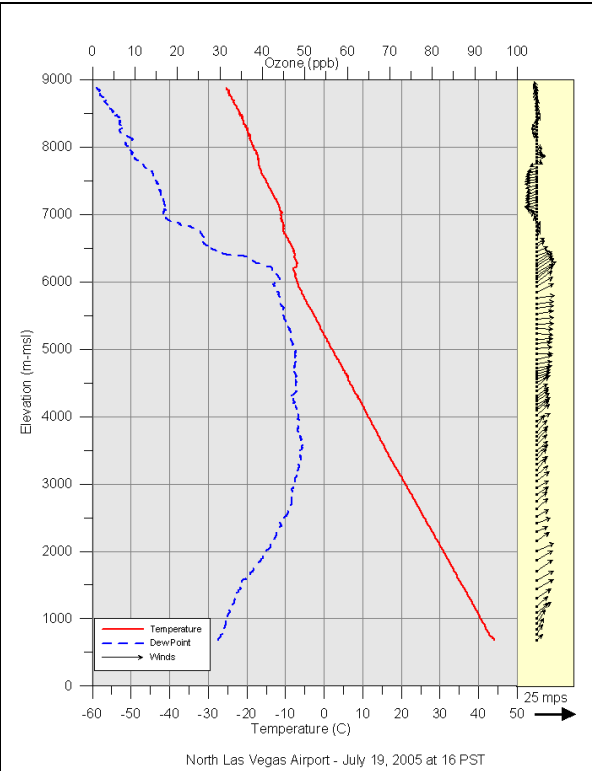
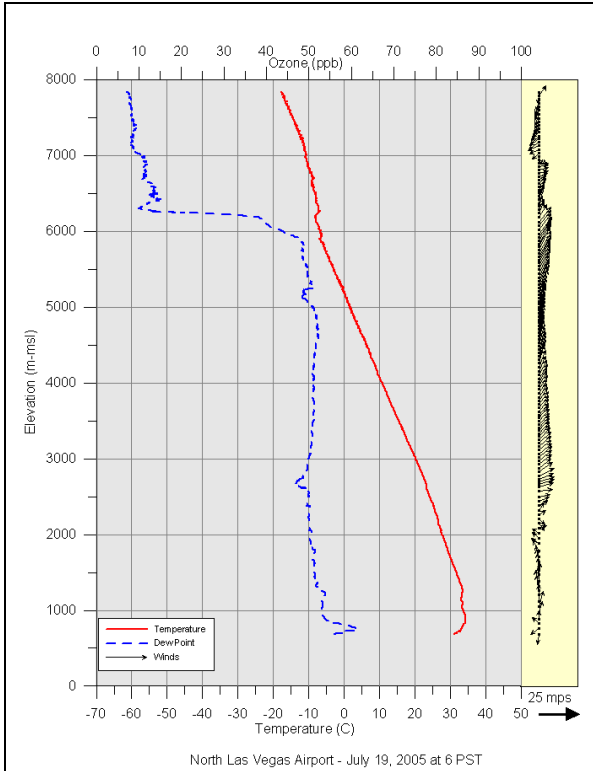

July 19, 2005

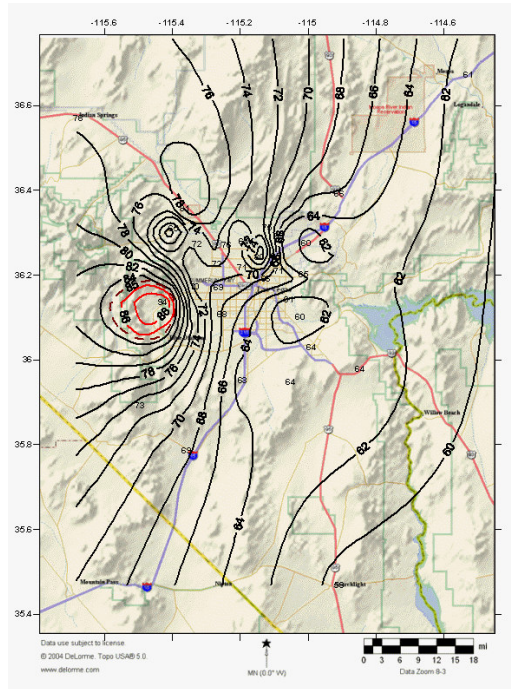
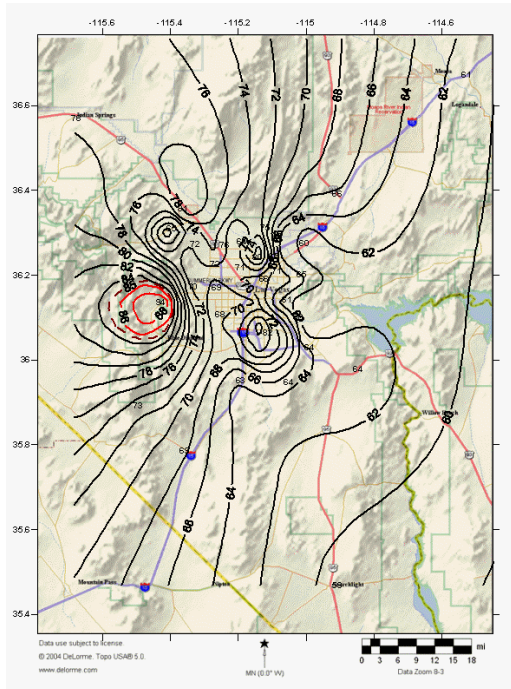
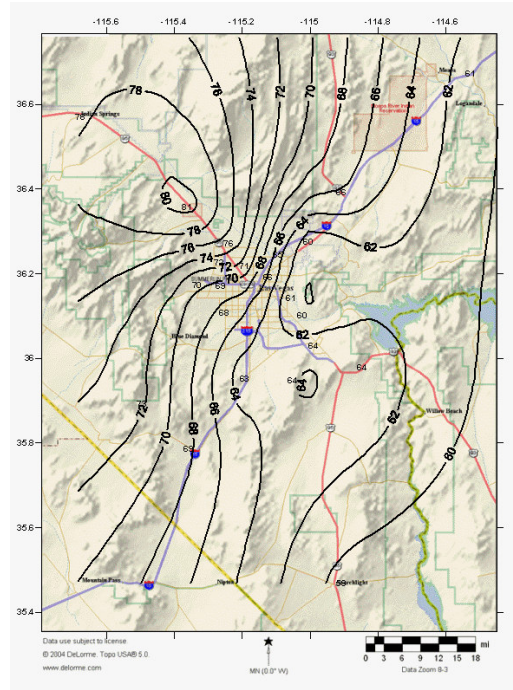
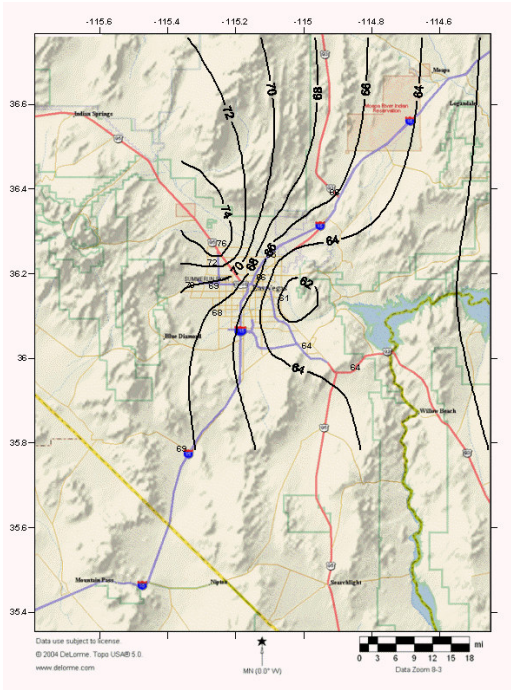

July 20, 2005

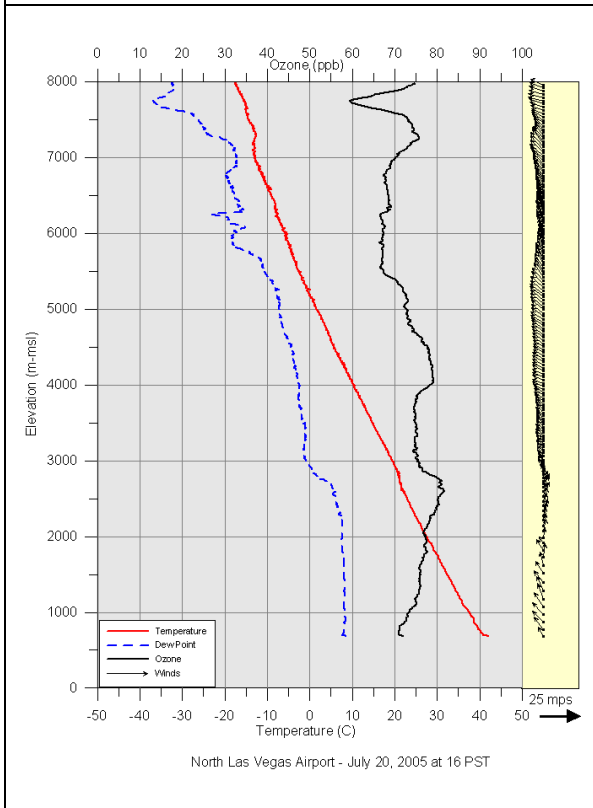
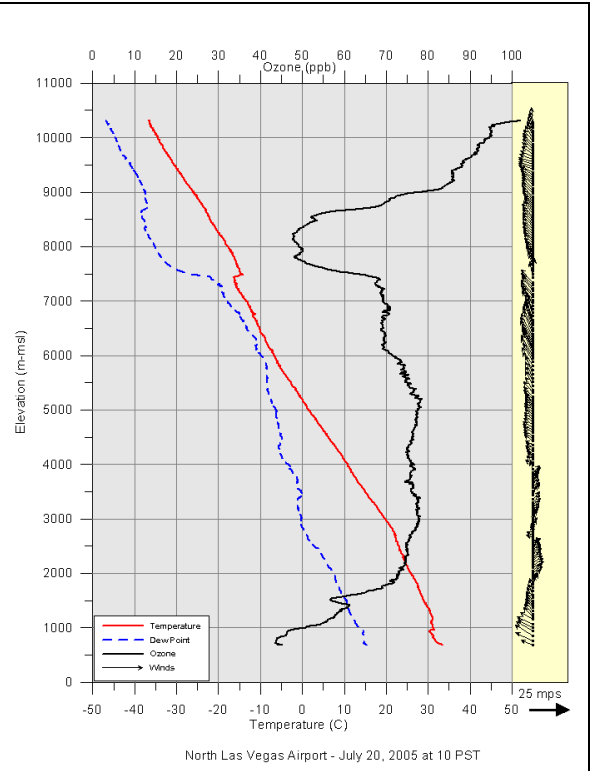
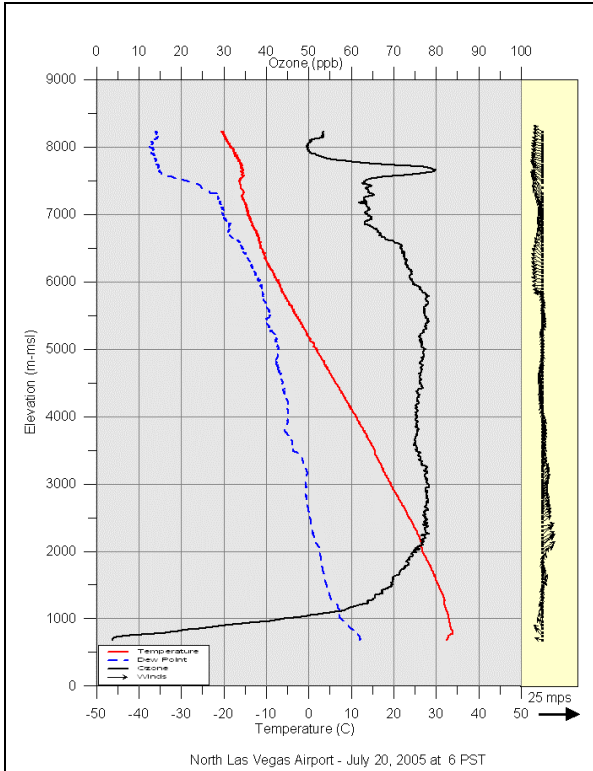

July 20, 2005

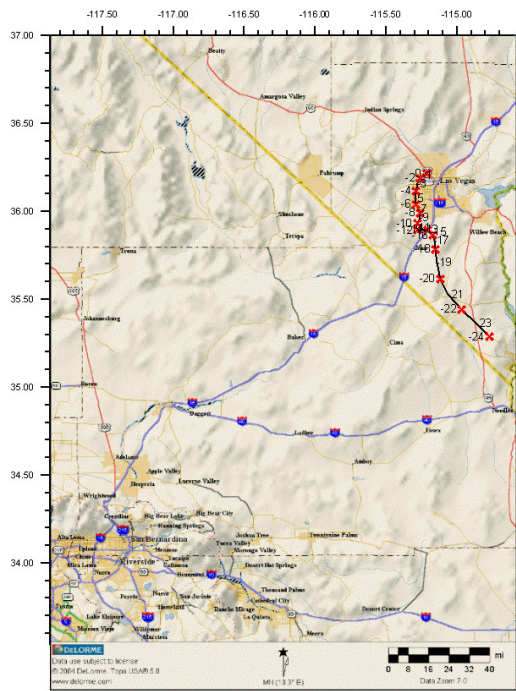
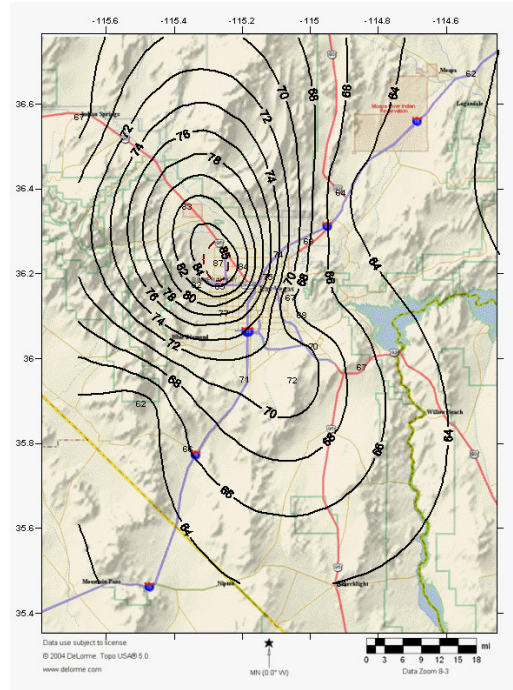
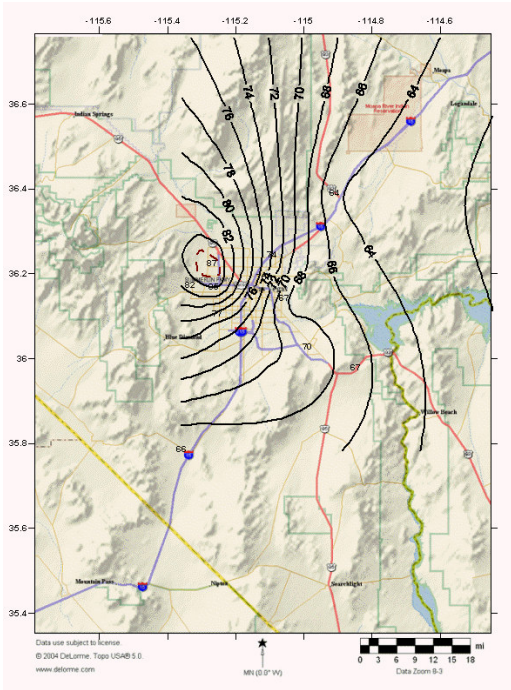

August 6, 2005

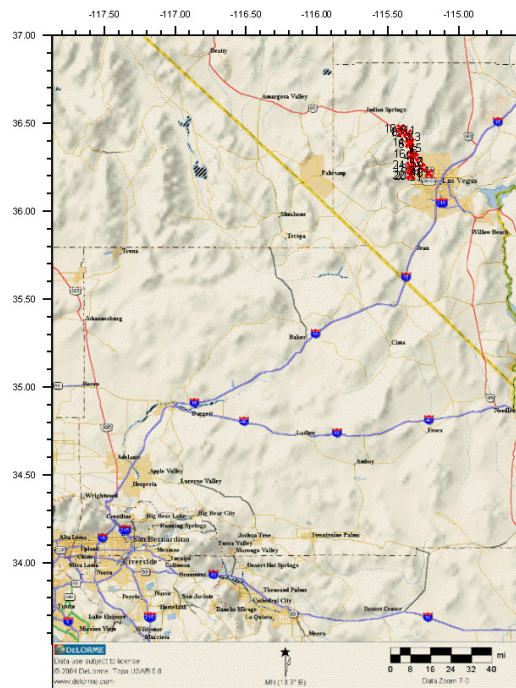
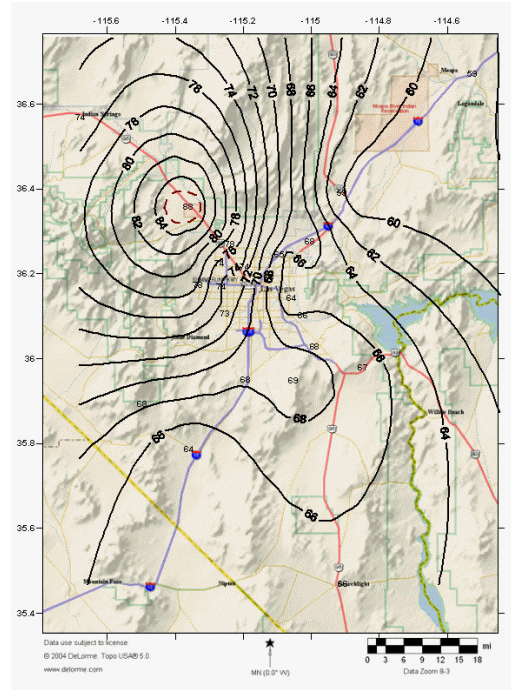
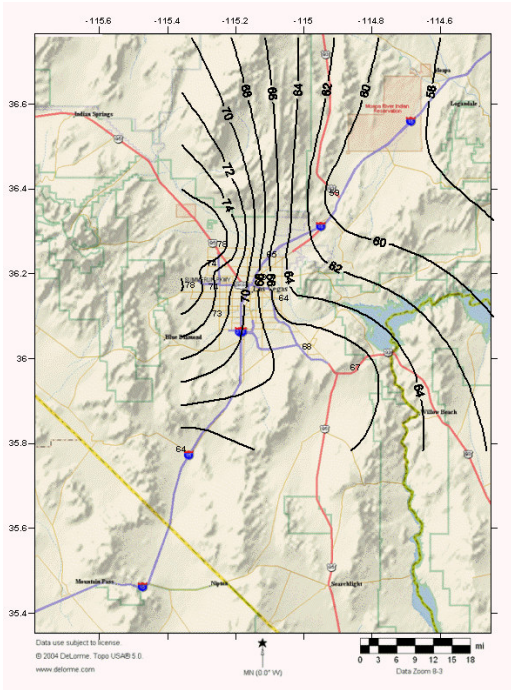

August 10, 2005